

Installation Guide

Applicable models

This installation sheet applies to AppStat controllers for fan coil units. The model numbers for these models end with "0001". Additional information for the controllers can be found in the document *Installation, Operation and Application Guide for the AppStat* which is available on the KMC partners web site.

Illustration 1—Fan Coil Unit models

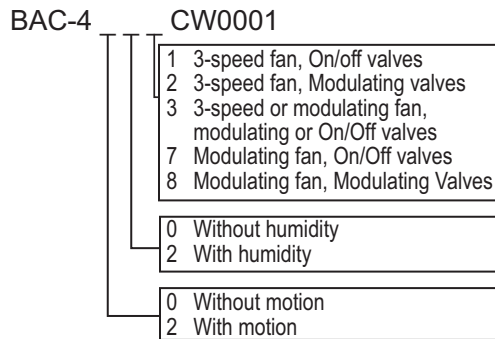

Planning for motion sensing

For models with a motion sensor mount the AppStat on a wall that will have an unobstructed view of the typical traffic in the coverage area. When choosing a location, do not install the sensor in the following areas.

- ◆ Behind curtains or other obstructions
- ◆ In locations that will expose it to sunlight or heat sources
- ◆ Near a heating or cooling inlet or outlet.

Illustration 2—Typical motion sensing coverage area

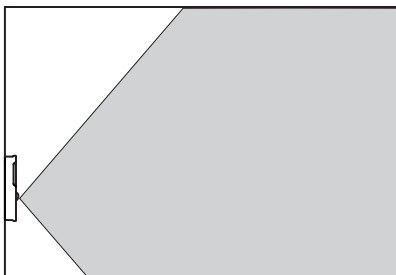

The effective detection range is approximately 10 meters or 33 feet. Factors that may reduce the range include:

- ◆ The difference between the surface temperature of the object and the background temperature of the room is too small.
- ◆ Object movement in a direct line toward the sensor.
- ◆ Very slow or very fast object movement.
- ◆ Obstructions as shown in the illustration *Typical motion sensing coverage area* on page 1.

False detections may be triggered by:

- ◆ The temperature inside the detection range suddenly changes because of the entry of cold or warm air from an air-conditioning or heating unit.
- ◆ The sensor being directly exposed to sunlight, an incandescent light, or other source of far-infrared rays.
- ◆ Small animal movement.

Mounting the AppStat

For the most accurate performance, install the AppStat on an inside wall where it can sense the average room temperature. Avoid locations with direct sunlight, heat sources, windows, air vents, and air circulation or obstructions such as curtains, furniture, etc.

The AppStat must not be:

- ◆ Mounted on an exterior wall.
- ◆ Mounted on or near an object with large a thermal mass such as a concrete block wall.
- ◆ Blocked from normal air circulation by obstructions.
- ◆ Exposed to heat sources such as lights, computers, copiers, or coffee makers, or to direct sunlight at any time of the day.
- ◆ Exposed to drafts from windows, diffusers, or returns.

- ◆ Exposed to air flow through connecting conduits or empty spaces behind walls.

For models with motion sensing, see the topic, [Planning for motion sensing](#).

Rough-in preparation

Complete rough-in wiring at each location before mounting an AppStat. This includes the following steps.

- ◆ Install the supplied mounting base directly to a wall, a vertical electrical box, or a box with a wall plate kit.
- ◆ Routing the connecting cable or cables from the AppStat to the equipment it is controlling.
- ◆ If required, install an appropriate wall plate kit.
- ◆ Block leaks and airflow from conduits with plumber's putty or similar material.
- ◆ If replacing an existing thermostat, label existing wires for reference when removing the existing thermostat.

Illustration 3—AppStat mounting base details

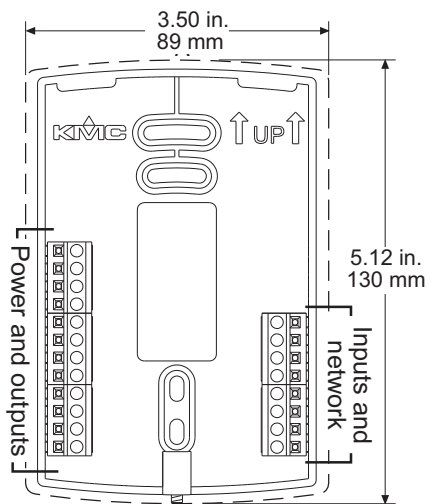

Installing the AppStat

To install the controller on a mounting base, do the following:

1. Turn the Allen screw in the base of the sensor clockwise until it clears the case.

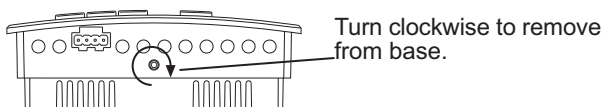

2. Swing the AppStat away from the mounting base to remove it.
3. Route wiring for the AppStat through the

mounting base.

4. Position the base with the embossed UP toward the ceiling and fasten it directly to a vertical 2 x 4 inch electrical box. For horizontal boxes or 4 x 4 applications, use a wall plate kit. See [Installation accessories on page 4](#) for part numbers.
5. Connect the wires for the AppStat to the terminals in the mounting base.
6. Place the top of the sensor over the top of the mounting base and swing it down over the Allen screw bracket. Be careful not to pinch any wiring.
7. Turn the Allen screw counterclockwise until it backs out of the mounting base and engages the case.



Caution

To prevent mounting screw heads from touching the circuit board in the controller, use only the mounting screws supplied by KMC Controls. Using screws other than the type supplied may damage the AppStat.

Connecting inputs

The inputs for the AppStat are configured for specific functions and do not require set up in the field. Not all inputs are required for every model or application.

Illustration 4—FCU inputs

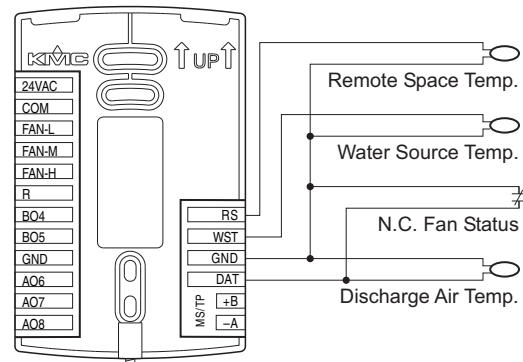

Remote space temperature sensor (optional)

Connect a 10kΩ, Type II thermistor temperature sensor to the remote space temperature (RS) input and ground (GND) terminals. The input includes

the internal pull-up resistor. An STE-6011W10 sensor is suitable for this application. Follow the instructions supplied with the sensor for installation.

When a remote space temperature input is connected to the AppStat, the remote temperature is used instead of the internal temperature sensor.

Fan status switch (optional)

Connect a Normally Closed Fan Status switch to the Discharge Air Temperature (DAT) input and ground (GND) terminals. The input includes the internal pull-up resistor. A CSE-1102 differential pressure switch is suitable for this application. Follow the instructions supplied with the switch for installation.

Water temperature sensor

Connect a 10k Ω , Type III thermistor temperature probe to the water temperature (WST) input. The input includes the internal pull-up resistor. An STE-1455 sensor is suitable for this application. Follow the instructions supplied with the sensor for installation.

Note: The water temperature sensor is a required input sensor for 2-pipe fan coil units.

Discharge air temperature

Connect a 10k Ω , Type III thermistor temperature probe to the discharge air temperature (DAT) input. The input includes the internal pull-up resistor. An STE-1405 sensor is suitable for this application. Follow the instructions supplied with the sensor for installation.

Connecting outputs

The AppStat outputs are model dependent and are configured for specific applications.

- ◆ No field programming or set up is required or possible.
- ◆ Depending on model and application, the AppStat outputs are designed for either 24 volt AC or 0-10 volt DC loads.
- ◆ The outputs may represent analog or digital signals.



Caution

Improperly connecting loads or equipment to output terminals may damage the equipment. Connect only as shown in the following diagrams or application drawings.

Illustration 5—FCU output terminals

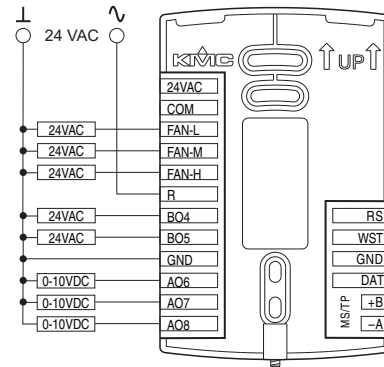

Connecting power

The AppStat requires an external, 24 volt, AC power source. Use the following guidelines when choosing and wiring transformers.

- ◆ Use only a Class-2 transformer of the appropriate size to supply power.
- ◆ KMC Controls recommends powering the AppStat from a dedicated controls transformer.
- ◆ Connect the transformer's neutral lead to the COM terminal.
- ◆ Connect the AC phase lead to the 24VAC terminal.
- ◆ Power is applied to the controller when the transformer is powered.

See [Installation accessories on page 4](#) for a list of transformers available from KMC Controls, Inc.

Illustration 6—Wiring for AppStat power

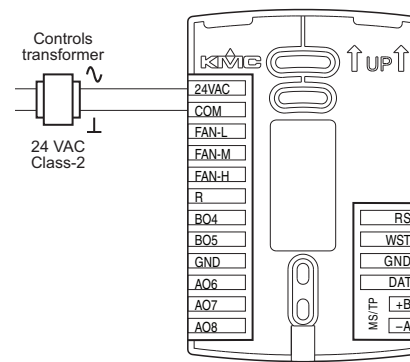

Maintenance

Remove dust as necessary from the holes in the top and bottom. Clean the display with soft, damp cloth and mild soap.

Specifications

AppStat specifications are subject to change without notice.

Supply Voltage	24 volts AC (-15%, +20%), 50-60 Hz, 12 VA, Class 2 only
Inputs	0-12 volts DC with internal 10k Ω pull-up resistors
Relay outputs	SPST, 24 volts, 1 amp AC or DC Maximum for all relay outputs is 3 amps
Analog outputs	Short protected 10mA 0-12 VDC
Environmental limits	Operating 34 to 125° F (1.1 to 51.6° C) Shipping -40 to 140° F (-40 to 60° C) Humidity 0 to 95% RH (non-condensing)
Regulatory	UL 916 Energy Management Equipment FCC Class A, Part 15, Subpart B and complies with Canadian ICES-003 Class A

This device complies with part 15 of the FCC Rules. Operation is subject to the following two conditions: (1) This device may not cause harmful interference, and (2) this device must accept any interference received, including interference that may cause undesired operation.

Installation accessories

The following accessories are available from KMC Controls, Inc.

XEE-6111-040	Single-hub 120 volt power transformer
XEE-6112-040	Dual-hub 120 volt power transformer
XEE-6311-075	120/240/277/480VAC, 24 VAC, 75 VA transformer
HMO-10000W	White mounting plate kit for retrofit on horizontal boxes or 4 x 4 handy boxes

Additional resources

The latest support files are always available on the KMC Controls web site.

For detailed specifications, installation, operating, application, and system integration information, see [The Installation, Operation, and Application Guide for AppStat](#).



For additional specifications information, see the [BAC-4000 AppStat Data Sheet](#).



Important Notices

The material in this document is for information purposes only. The contents and the product it describes are subject to change without notice. KMC Controls, Inc. makes no representations or warranties with respect to this document. In no event shall KMC Controls, Inc. be liable for any damages, direct or incidental, arising out of or related to the use of this document.

KMC Controls, Inc.

P.O. Box 497
19476 Industrial Drive
New Paris, IN 46553
U.S.A.
TEL: 1.574.831.5250
FAX: 1.574.831.5252
E-mail: info@kmccontrols.com