

## Installation Guide

### Mounting

1. Clean the lines upstream from the valve. Remove any debris (welding slag, pipe scale, or other contaminants) larger than 1/16 inch (1.6 mm).

**NOTE:** If the system experiences large amounts of debris, steps should be taken to keep the system clean, such as 20 mesh strainer installed upstream of the valve.

2. Align the valve assembly according to the system flow requirements (see the illustration below).
3. The valve may be mounted on either vertical or horizontal pipe lines. On horizontal lines, mount the valve so the actuator is positioned upright and over the valve. (Leave sufficient room on all sides to service the actuator and valve.)

### ⚠ CAUTION

To prevent condensation from dripping onto the actuator housing on horizontal lines, mount the valve with the actuator in the upright position or, at most, at a 45° angle.

4. Install approved flange gaskets (not supplied by KMC Controls) and bolt the valve to the pipes.
5. Eliminate air from the system to keep the valves full of fluid during operation.

### Wiring

Wiring is dependent on the type of actuator and the desired options that are available. Consult the actuator model label and then the relevant sections in the [MEP-7500/7800 Series Actuators Installation Guide](#) for detailed instructions on the applicable wiring, feedback selector, and actuator/signal range reset (auto-mapping) of the valve's actuator. (See the More Information section on the next page.)

### ⚠ CAUTION

Using mineral oil lubricants or other incompatible substances in system fluids may damage EPDM rubber seals in valves. Before using any lubricant or additive in a water or ethylene glycol base, consult the substance manufacturer for compatibility with EPDM (Ethylene Propylene Diene Monomer).

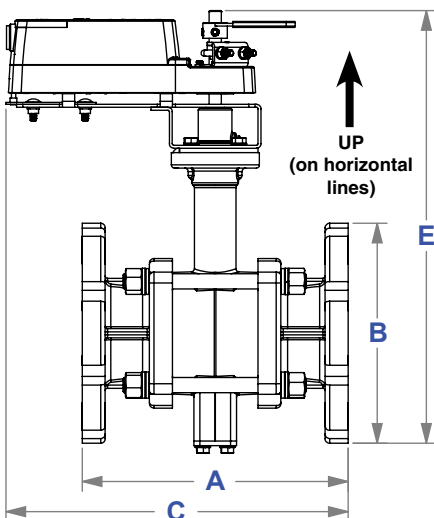

Full CW = Valve Open

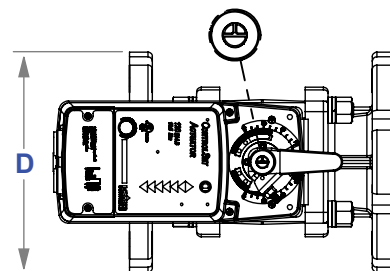

Full CCW = Valve Closed

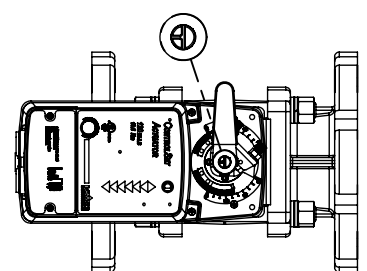

Size	A	B	C	D	E	Weight (lb.)
4"	11	9	13.75	9	17.75	70
5"	12.375	10	14.75	10	18	80
6"	13.875	11	15.625	11	18.875	95

## Operation

After the mechanical and electrical installations have been completed, cycle the actuator to verify the direction of rotation for normal operation and fail-safe if so equipped.

## Maintenance

No routine maintenance is required. The motors are permanently lubricated. Careful installation will also ensure long term reliability and performance.

## Accessories/Repair Parts

CME-7001	Single auxiliary switch, 1 SPDT
CME-7002	Dual auxiliary switch, 2 SPDT
HMO-4536	Adjustable stop kit
MEP-7xxx	Replacement actuator (see label on actuator or data sheet)

## More Information

For **models, specifications,** and additional information, see the **VEB-53 Series Data Sheet** on the KMC web site ([www.kmccontrols.com](http://www.kmccontrols.com)).

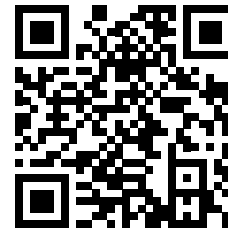

For **wiring, feedback/direction selectors, actuator/signal range reset (auto-mapping),** and other information, see the **MEP-7500/7800 Series Installation Guide**.

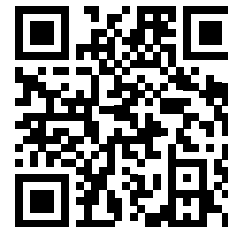

For **actuator specifications** and other information, see the **MEP-7500/7800 Series Data Sheet**.

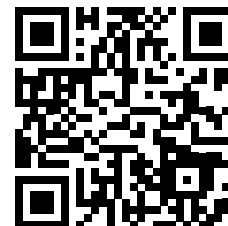

For **accessories, troubleshooting,** and other information, see the **MEP-7500/7800 Series Application Guide**.

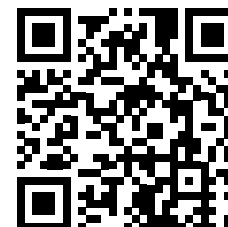

**KMC Controls, Inc.**  
19476 Industrial Drive  
New Paris, IN 46553  
574.831.5250  
[www.kmccontrols.com](http://www.kmccontrols.com)  
[info@kmccontrols.com](mailto:info@kmccontrols.com)