

CONTENTS

Introduction.....	1
Applications by Model	1
General Wiring Considerations.....	2
DCV (Demand Control Ventilation).....	3
Air Handling Unit (BAC-19xx36).....	4
Inputs and Outputs List	4
Wiring	5
Sequence of Operation	6
(2-Pipe and 4-Pipe) Fan Coil Unit (BAC-19xx63).....	7
Inputs and Outputs List	7
2-Pipe Wiring.....	8
2-Pipe Sequence of Operation	9
4-Pipe Wiring.....	10
4-Pipe Sequence of Operation	11
(4-Pipe) Unit Ventilator (BAC-19xx36)	12
Inputs and Outputs List	12
Wiring	13
Sequence of Operation.....	14
Heat Pump Unit (BAC-19xx63).....	15
Inputs and Outputs List	15
Wiring	16
Sequence of Operation.....	17
Roof Top Unit (BAC-19xx63).....	18
Inputs and Outputs List	18
Wiring	19
Sequence of Operation.....	20
Important Notices.....	21
Support.....	21



INTRODUCTION

This guide describes sequences of operation and wiring for different applications of KMC Conquest BAC-19xxxx FlexStats.

For general installation and configuration procedures, see the **BAC-19xxxx FlexStat Installation Guide** at kmccontrols.com.

For configuration of settings, passwords, communication options, display customization, wiring considerations, and troubleshooting, see the **BAC-19xxxx FlexStat Application Guide**.

For specifications and accessories, see the **BAC-190000 Series FlexStat Data Sheet**.

For instructions on custom configuration and programming, see the Help system in the software tool.

APPLICATIONS BY MODEL

BAC-19xx**36**C models:

- Air Handling Units
- Unit Ventilators (4-Pipe)

BAC-19xx**63**C models:

- Fan Coil Units (2- and 4-Pipe)
- Heat Pump Units
- Roof Top Units



GENERAL WIRING CONSIDERATIONS

NOTE: See the **BAC-19xxxx FlexStat Application Guide** for more important information about network and other wiring.

⚠ CAUTION

Although typical terminal code letters are shown in the illustrations in this document, check the schematics of your unit for wiring details!

⚠ CAUTION

The BAC-19xxxx models are **NOT** compatible with the backplates of older BAC-10xxx/12xxxx/13xxxx/14xxxx FlexStats! If replacing an older FlexStat, replace the backplate as well.

⚠ CAUTION

To avoid damage from ground loops and other communication issues in networked FlexStats, correct phasing on MS/TP network and power connections on ALL the networked controllers is critically important.

⚠ CAUTION

Relays are for Class-2 voltages (24 VAC) only. Do not connect line voltage to the relays!

Do not mistakenly connect 24 VAC to an analog output ground.

NOTE: FlexStat relays are **NO, SPST (Form "A")**. (To emulate binary outputs with the analog outputs, set the output voltage to be either 0 or 12 VDC in Control Basic.)

- Because of the many connections (power, network, inputs, outputs, and their respective grounds or switched commons), **be sure wiring is well planned before installation of conduit!**
- **Make sure that conduit for all wiring has adequate diameter for all necessary wiring.** Using 1-inch conduit and junction boxes is recommended! Use external junction boxes above the ceiling or in another convenient location as needed to make connections that run to the FlexStat's junction box.
- To prevent excessive voltage drop, **use a conductor size that is adequate for the wiring length! Allow plenty of "cushion" to allow for transient peaks during startup.**
- Using **multiple conductor wires** for all inputs (e.g., 8 conductor) and outputs (e.g., 12 conductor) is recommended. Grounds for all the inputs can be combined on one wire.

DCV (DEMAND CONTROL VENTILATION)

BAC-195xxx and BAC-193xxx model FlexStats include CO₂ sensors for DCV operation in (6/3) RTU, HPU, 4-pipe FCU, and (3/6) AHU applications with an outside air damper. See the illustrations and descriptions below of Basic and Standard DCV options and operation.

See the [BAC-19xxxx FlexStat Application Guide](#) for more information. See also:

- [Air Handling Unit \(BAC-19xx36\) on page 4](#)
- [Heat Pump Unit \(BAC-19xx63\) on page 15](#)
- [\(4-Pipe\) Unit Ventilator \(BAC-19xx36\) on page 12](#)
- [Roof Top Unit \(BAC-19xx63\) on page 18](#)

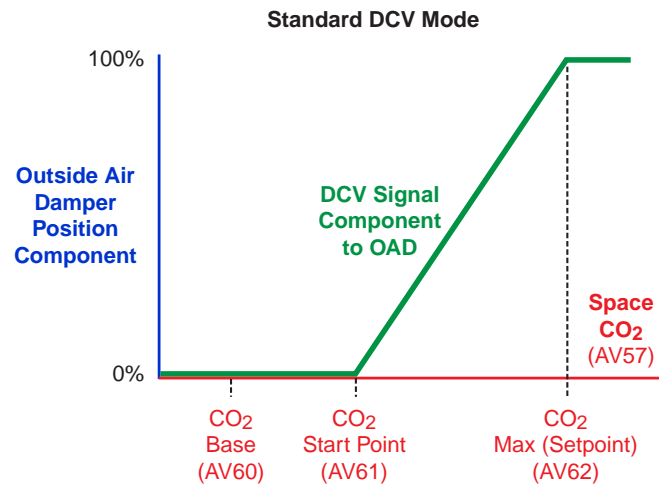
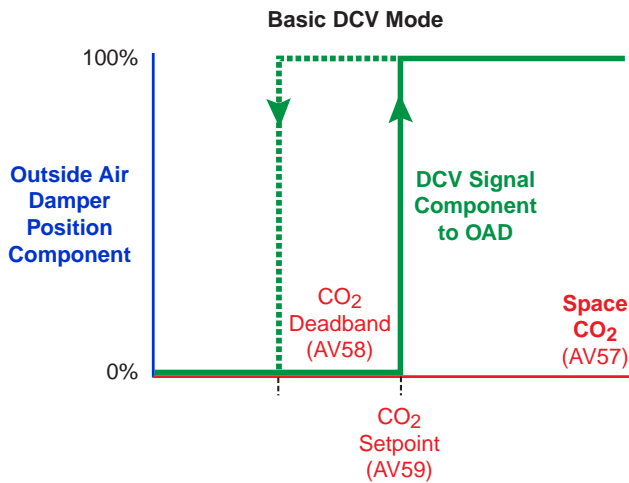

DEMAND CONTROL VENTILATION					
Description	Menu Options	Notes	Default Value	Object	DCV Mode
CO ₂ Level		Available as a rotation value on the display.	0 ppm	AV57	
Select DCV Mode	DCV Mode	Select None, Basic, or Standard.	None	MSV12	
Basic DCV Setpoint	CO2 Basic Setpoint	In Basic DCV mode, the desired CO ₂ level at which point the economizer damper opens for maximum outside air flow.	1200 ppm	AV59	Basic
Basic DCV Deadband	CO2 Basic Deadband	In Basic DCV mode, the amount the CO ₂ level must drop below the setpoint before DCV control is relinquished (and outside DCV air flow returns to minimum).	200 ppm	AV58	
Standard DCV Baseline (Outside Air CO ₂ Level)*		In Standard DCV mode, the presumed average CO ₂ concentration level of outside air at the building's location. Every week after installation, the lowest detected reading in the previous week is written into AV60 (replacing the original default or previous value).	380 ppm	AV60	Standard
Standard DCV Start Point*		In Standard DCV mode, the CO ₂ level (setpoint) at which the economizer damper begins to modulate open . It equals the DCV CO ₂ baseline plus 200 ppm, and the value is recalculated weekly.	580 ppm	AV61	
Standard DCV Maximum Allowed CO ₂ Level*		In Standard DCV mode, the maximum allowed CO ₂ concentration level during an occupied period. The economizer damper modulates to fully open at this level. It equals the DCV CO ₂ baseline plus 600 ppm, and the value is recalculated weekly.	980 ppm	AV62	
*NOTE: Standard DCV values are self-calculating and are not configurable by the user in the FlexStat menu.					

AIR HANDLING UNIT (BAC-19XX36)

Inputs and Outputs List

AHU	
Inputs	
(AI1)	INTERNAL Space Temperature Sensor*
AI2/IN2	Remote Room Temp. Sensor
AI3/IN3	Discharge Air Temperature
AI4/IN4	Outside Air Temperature
AI5/IN5	Analog Input #5
BI6/IN6	Fan Status
BI7/IN7	Low Limit Status
(AI8)	INTERNAL Humidity Sensor*
(BI9)	INTERNAL Motion Sensor*
(AI10)	INTERNAL CO2 Sensor*
*Internal temperature sensor is on all models. Optional internal humidity, motion, and CO2 sensors are on applicable models.	
Outputs	
BO1/RLY1	(Modulating) Fan Start/Stop
BO2/RLY2	On/Off Cooling*
BO3/RLY3	On/Off Heating*
AO4/OUT4	Analog Output #4
AO5/OUT5	Analog Output #5
AO6/OUT6	Modulating Fan Speed Control
AO7/OUT7	Modulating Cooling Valve
AO8/OUT8	Modulating Heating Valve
AO9/OUT9	Economizer Output
*AO7 and BO2 are controlled simultaneously.	
**AO8 and BO3 are controlled simultaneously.	

NOTE: See also **DCV (Demand Control Ventilation)** on page 3.

NOTE: Binary Output (BO1–BO3) terminals are relays and are used with SC terminals instead of GND terminals.

NOTE: Universal (analog) inputs (AIx/INx) and outputs (AOx/OUTx) are used with GND terminals. They can be configured to emulate binary (on/off or voltage/no-voltage) objects.

NOTE: Universal Input (INx) terminal = Analog Input (AIx) object or Binary Input (BIx). Universal Output (OUTx) terminal = Analog Output (AOx) object. Relay output (RLYx) = Binary Output (BOx) object.

NOTE: Unused inputs and outputs are available for use with custom configuration and programming in KMC software.

Air Handling Unit with Modulating Fan, Modulating and On/Off Heating and Cooling, Economizer, and Humidity, Motion and CO2 Sensors Model: BAC-19xx36C(E)



If controllers are to be networked together via MS/TP, turn **ON** EOL switch on the controllers at both physical ends of the network. Connect shield wires together and to earth ground at only one point, but do not connect to controllers.

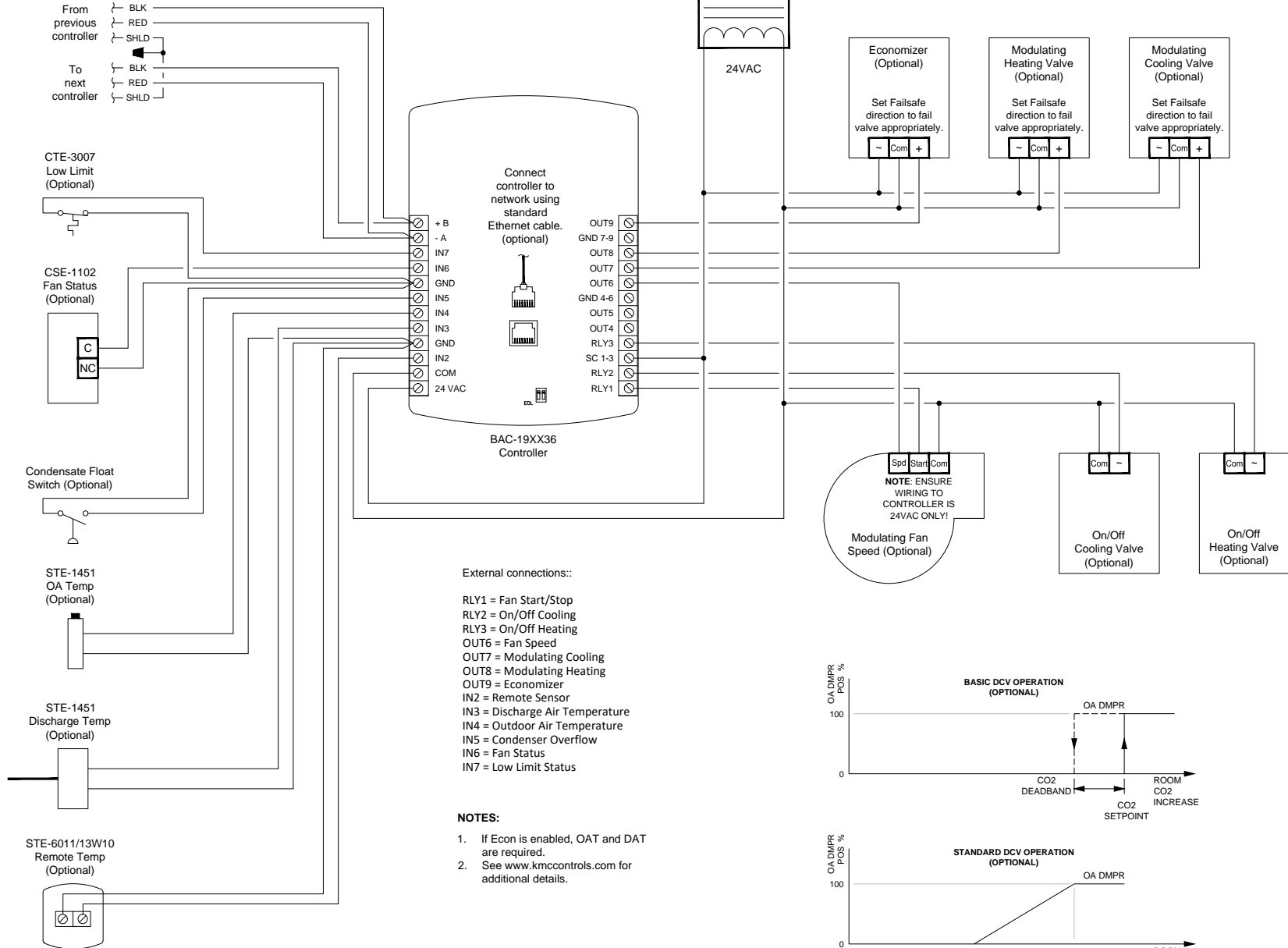

External connections::

- RLY1 = Fan Start/Stop
- RLY2 = On/Off Cooling
- RLY3 = On/Off Heating
- OUT6 = Fan Speed
- OUT7 = Modulating Cooling
- OUT8 = Modulating Heating
- OUT9 = Economizer
- IN2 = Remote Sensor
- IN3 = Discharge Air Temperature
- IN4 = Outdoor Air Temperature
- IN5 = Condenser Overflow
- IN6 = Fan Status
- IN7 = Low Limit Status

NOTES:

1. If Econ is enabled, OAT and DAT are required.
2. See www.kmccontrols.com for additional details.

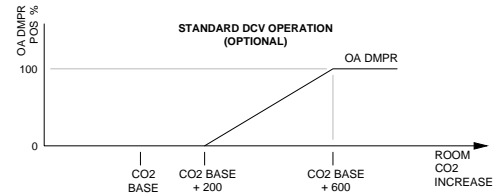
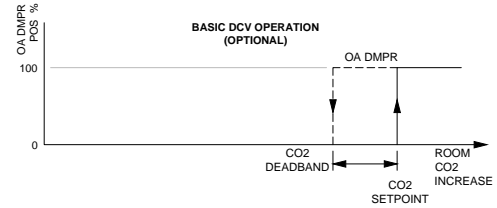



Air Handling Unit with Modulating Fan, Modulating and On/Off Heating and Cooling, Economizer, and Humidity, Motion and CO2 Sensors Model: BAC-19xx36C(E)

SEQUENCE OF OPERATION:

1. Occupancy: The occupancy mode follows the internal schedule. If motion (optional) is not sensed within the standby timer during occupied mode, the unit goes into standby mode until motion is sensed again.
2. On/off fan: When the fan mode is set to *Auto* and heating, cooling or economizer is called for, the fan starts. Once the space temp returns to setpoint, there is no call for heating, cooling nor economizer and the fan-off-delay expires (2 minutes), the fan shuts off. During the occupied and standby modes, the fan output is energized any time the fan mode is set to *On*.
3. Modulating fan: When the fan mode is set to *Auto* and either valve opens, the fan starts at minimum fan speed. Once the active valve is fully open, as the space temperature deviates further from setpoint, the fan speed increases until it reaches maximum fan speed. As the space temperature begins to return to setpoint, the fan speed modulates toward minimum fan speed. The fan runs at minimum speed until the space temp further returns to setpoint and the active valve closes. During the occupied and standby modes, the fan is energized at minimum fan speed while both valves are closed if the fan mode is set to *On*. The fan follows the normal sequence above once either valve opens.
4. When the fan starts, if the normally closed fan status switch (optional) doesn't open within 10 seconds, all heating, cooling and economizer outputs are deenergized. The fan output remains enabled and heating/cooling/economizer outputs remain disabled until the fan status switch opens.
5. Modulating heating: As space temp drops below the heating setpoint, the heating valve modulates open. As the space temp rises toward the heating setpoint, the heating valve modulates closed. If the fan is set to *Auto*, the valve is held shut until the space temp drops below the heating setpoint minus the heating span at which point the valve opens and follows the normal sequence.
6. Modulating Cooling: As space temp rises above the cooling setpoint, the cooling valve modulates open. As the space temp drops toward the

cooling setpoint, the cooling valve modulates closed. While economizing, the cooling valve is held shut the first 50% of the cooling span above the cooling setpoint and then modulates open. If the fan is set to *Auto*, the valve is held shut until the space temp rises above the cooling setpoint plus the cooling span at which point the valve opens and follows the normal sequence.

7. On/off valves: On a call for heating or cooling, the appropriate valve opens once the space temperature is more than half the span away from the setpoint. When the space temperature is within 5% of the span of setpoint, the opened valve closes.
8. Economizer: During occupied mode, if outside air temp (OAT) drops below the economizer enable temp and there is a call for cooling, econ mode is enabled. Econ mode is disabled if OAT rises 1 deg above the econ enable temp. While economizing, the outside air damper (OAD) modulates to maintain discharge air temp (DAT). As space temp rises above the cooling setpoint, DAT setpoint resets from the space temp to the minimum DAT. While economizing, the OAD is open to the greater of the minimum damper position or DAT control. The OAD is shut during unoccupied mode and any time the fan is off.
7. If the space humidity (optional) rises above the dehumidification setpoint, the cooling valve is opened 100%. The heating valve then follows its normal operation to maintain the *COOLING* setpoint. Once the space humidity drops below the dehumidification setpoint minus its span, dehumidification ceases and the heating and cooling valves resume normal operation.
8. In Basic Demand Control Ventilation (DCV), the OA damper opens 100% as the CO2 level rises above the CO2 setpoint. As the CO2 level drops below the CO2 setpoint minus the CO2 deadband, the damper relinquishes to previous control.
9. In Standard DCV, the OA damper modulates from 0% open as the CO2 level rises from the CO2 base level +200 ppm to 100% open at the CO2 base level +600 ppm.
10. When both CO2 and economizer control are enabled, the damper responds to the greater of CO2 or economizer control.

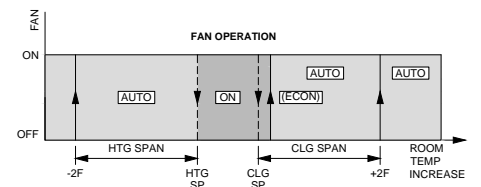
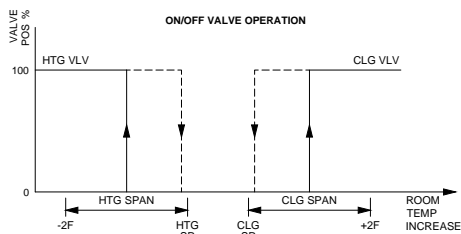
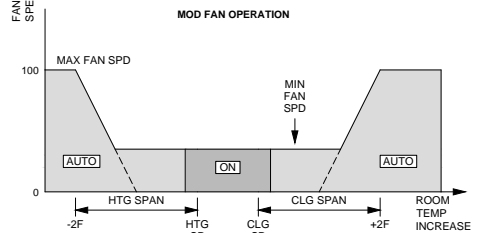
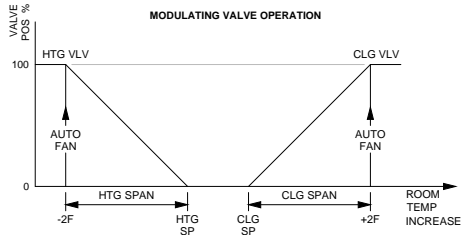
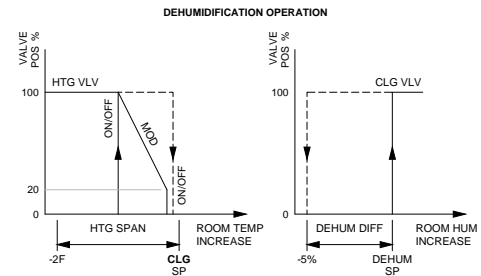
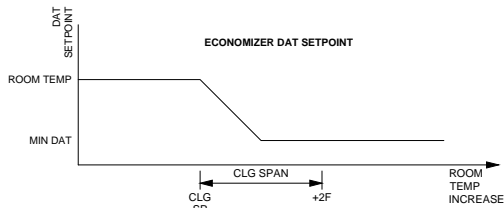

(2-PIPE AND 4-PIPE) FAN COIL UNIT (BAC-19XX63)

Inputs and Outputs List

FCU (2-PIPE)	
Inputs	
(AI1)	INTERNAL Space Temperature Sensor*
AI2/IN2	Remote Room Temp. Sensor
AI3/IN3	Discharge Air Temperature
AI4/IN4	Analog Input #4
BI5/IN5	Condensate Overflow (Float Switch)
BI6/IN6	Fan Status
AI7/IN7	Supply Water Temperature
(AI8)	INTERNAL Humidity Sensor*
(BI9)	INTERNAL Motion Sensor*
(AI10)	INTERNAL CO ₂ Sensor*
*Internal temperature sensor is on all models. Optional internal humidity, motion, and CO ₂ sensors are on applicable models.	
Outputs	
BO1/RLY1	3-Speed Fan Low Speed; Mod. Fan Start
BO2/RLY2	3-Speed Fan Medium Speed
BO3/RLY3	3-Speed Fan High Speed
BO4/RLY4	On/Off Heat/Cool Valve*
BO5/RLY5	On/Off Auxiliary Heat**
BO6/RLY6	Binary Output #6
AO7/OUT7	Modulating Heat/Cool Valve*
AO8/OUT8	Modulating Auxiliary Heat**
AO9/OUT9	Modulating Fan Speed Control
*AO7 and BO4 are controlled simultaneously.	
**AO8 and BO5 are controlled simultaneously.	

NOTE: For **unit ventilator** (with outside air damper) applications, see **(4-Pipe) Unit Ventilator (BAC-19xx36) on page 12**.

NOTE: Binary Output (BO1–BO6) terminals are relays and are used with SC terminals instead of GND terminals.

NOTE: Universal (analog) inputs (AIx/INx) and outputs (AOx/OUTx) are used with GND terminals. They can be configured to emulate binary (on/off or voltage/no-voltage) objects.

FCU (4-PIPE)	
Inputs	
(AI1)	INTERNAL Space Temperature Sensor*
AI2/IN2	Remote Room Temp. Sensor
AI3/IN3	Discharge Air Temperature
AI4/IN4	Analog Input #4
BI5/IN5	Condensate Overflow (Float Switch)
BI6/IN6	Fan Status
AI7/IN7	Analog Input #7
(AI8)	INTERNAL Humidity Sensor*
(BI9)	INTERNAL Motion Sensor*
(AI10)	INTERNAL CO ₂ Sensor*
*Internal temperature sensor is on all models. Optional internal humidity, motion, and CO ₂ sensors are on applicable models.	
Outputs	
BO1/RLY1	3-Speed Fan Low Speed; Mod. Fan Start
BO2/RLY2	3-Speed Fan Medium Speed
BO3/RLY3	3-Speed Fan High Speed
BO4/RLY4	On/Off Cooling Valve*
BO5/RLY5	On/Off Heating Valve**
BO6/RLY6	Binary Output #6
AO7/OUT7	Modulating Heat/Cool Valve*
AO8/OUT8	Modulating Auxiliary Heat**
AO9/OUT9	Modulating Fan Speed Control
*AO7 and BO4 are controlled simultaneously.	
**AO8 and BO5 are controlled simultaneously.	

NOTE: Universal Input (INx) terminal = Analog Input (AIx) object or Binary Input (BIx). Universal Output (OUTx) terminal = Analog Output (AOx) object. Relay output (RLYx) = Binary Output (BOx) object.

NOTE: Unused inputs and outputs are available for use with custom configuration and programming in KMC software.

2-Pipe Fan Coil Unit with Modulating and 3-Speed Fan, Modulating and On/Off Valve, Modulating and On/Off Auxiliary Heat and Humidity, Motion and CO2 Sensors Model: BAC-19xx63C(E)



If controllers are to be networked together via MS/TP, turn **ON** EOL switch on the controllers at both physical ends of the network. Connect shield wires together and to earth ground at only one point, but do not connect to controllers.

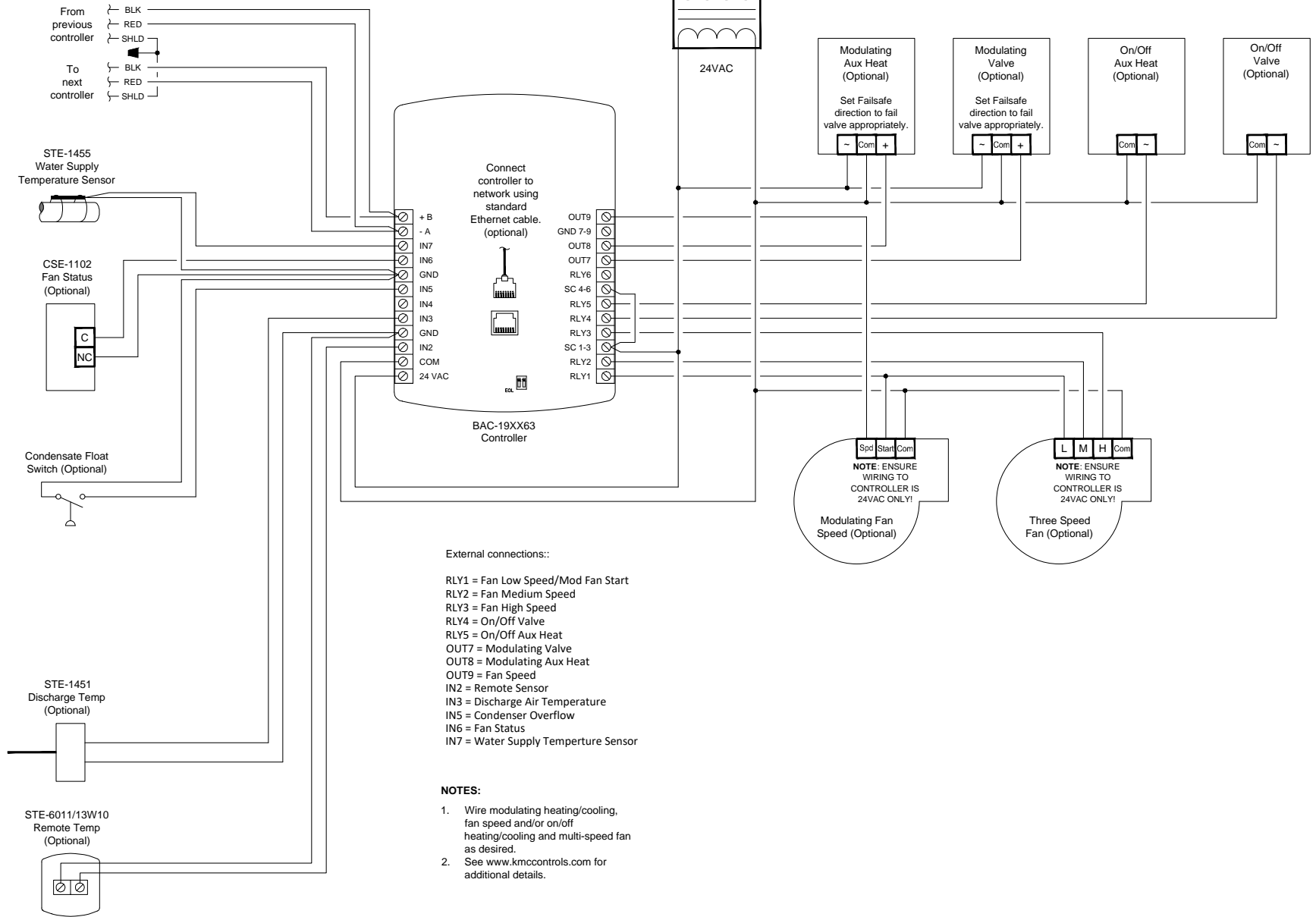



2-Pipe Fan Coil Unit with Modulating and 3-Speed Fan, Modulating and On/Off Valve, Electric Reheat, and Humidity, Motion and CO2 Sensors Model: BAC-19xx63C(E)

SEQUENCE OF OPERATION:

1. Occupancy: The occupancy mode follows the internal schedule. If motion (optional) is not sensed within the standby timer during occupied mode, the unit goes into standby mode until motion is sensed again.
2. 3 Speed fan: When the fan mode is set to *Auto* and the water valve is called for, the fan starts on low speed. As the space temperature deviates further from setpoint, the fan speed changes to medium. As the space temperature passes the active setpoint plus its span, high fan speed becomes the active speed. As the space temperature begins to return to setpoint, the active fan speed drops to medium. As the space temp further returns to setpoint, the fan speed switches to low. As the valve closes, all fan speeds are deenergized. During the occupied and standby modes, low fan speed is energized while the valve is closed if the fan mode is set to *On*. The fan follows the normal sequence above once the valve opens.
3. Modulating fan: When the fan mode is set to *Auto* and the water valve opens, the fan starts at minimum fan speed. Once the valve is fully open, as the space temperature deviates further from setpoint, the fan speed increases until it reaches maximum fan speed. As the space temperature begins to return to setpoint, the fan speed modulates toward minimum fan speed. The fan runs at minimum speed until the space temp further returns to setpoint and the valve closes. During the occupied and standby modes, the fan is energized at minimum fan speed while the valve is closed if the fan mode is set to *On*. The fan follows the normal sequence above once the valve opens.
4. When the fan starts at any speed, if the normally closed fan status switch (optional) doesn't open within 10 seconds, all heating and cooling outputs are deenergized. The fan output remains enabled and heating/cooling outputs remain disabled until the fan status switch opens.
5. Water evaluation mode: If the water supply temperature (WST) rises more than 10°F (AV56, adjustable) above space temp, hot water is said to be available. If the WST drops more than 10°F (AV56, adjustable) below space temp, chilled water is said to be available. As the WST comes within 8°F (AV56, adjustable, minus 2°F) of space temperature, neither hot nor chilled water are available. If the Water Type is determined to be *Unconditioned*, the water evaluation mode runs once every 6 hours for five minutes or until a valid water type is determined, whichever is reached first.
6. On/off valve: On a call for heating or cooling with the appropriate water present, the valve opens once the space temperature is more than half the span away from the setpoint. When the space temperature is within 5% of the span of setpoint, the valve closes.
7. Modulating valve: As space temperature deviates from setpoint with the appropriate water present, the valve modulates open until it is 100% open when the space temp is 50% of the span away from setpoint. As the temperature drops within 50% of the span of setpoint, the valve modulates closed.
8. Electric reheat: If electric reheat (optional) is present, on a call for heating with chilled water present, the reheat output behaves as if heating is called for with hot water present. With hot water present, electric reheat is locked out.

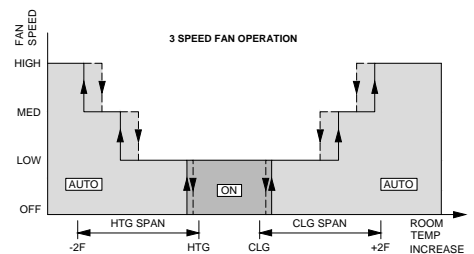
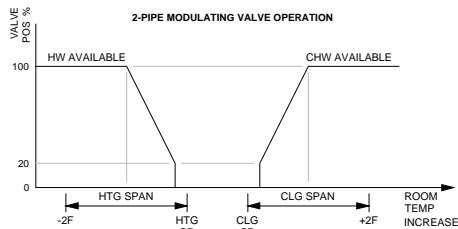
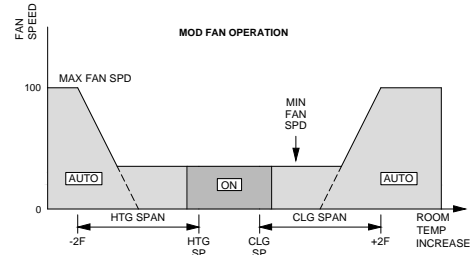
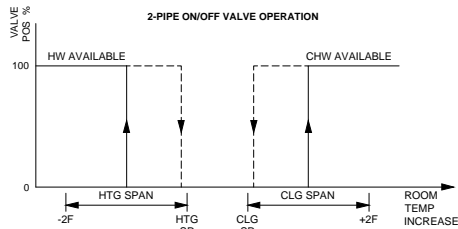
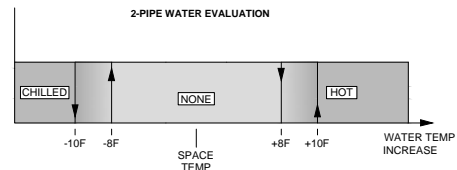
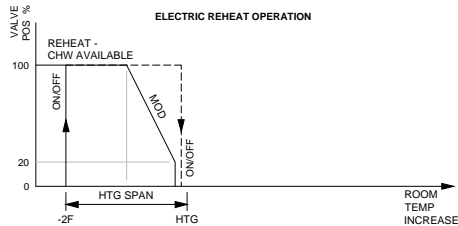

**4-Pipe Fan Coil Unit with Modulating and 3-Speed Fan,
Modulating and On/Off Valves and Humidity,
Motion and CO2 Sensors
Model: BAC-19xx63C(E)**



If controllers are to be networked together via MS/TP, turn **ON** EOL switch on the controllers at both physical ends of the network. Connect shield wires together and to earth ground at only one point, but do not connect to controllers.

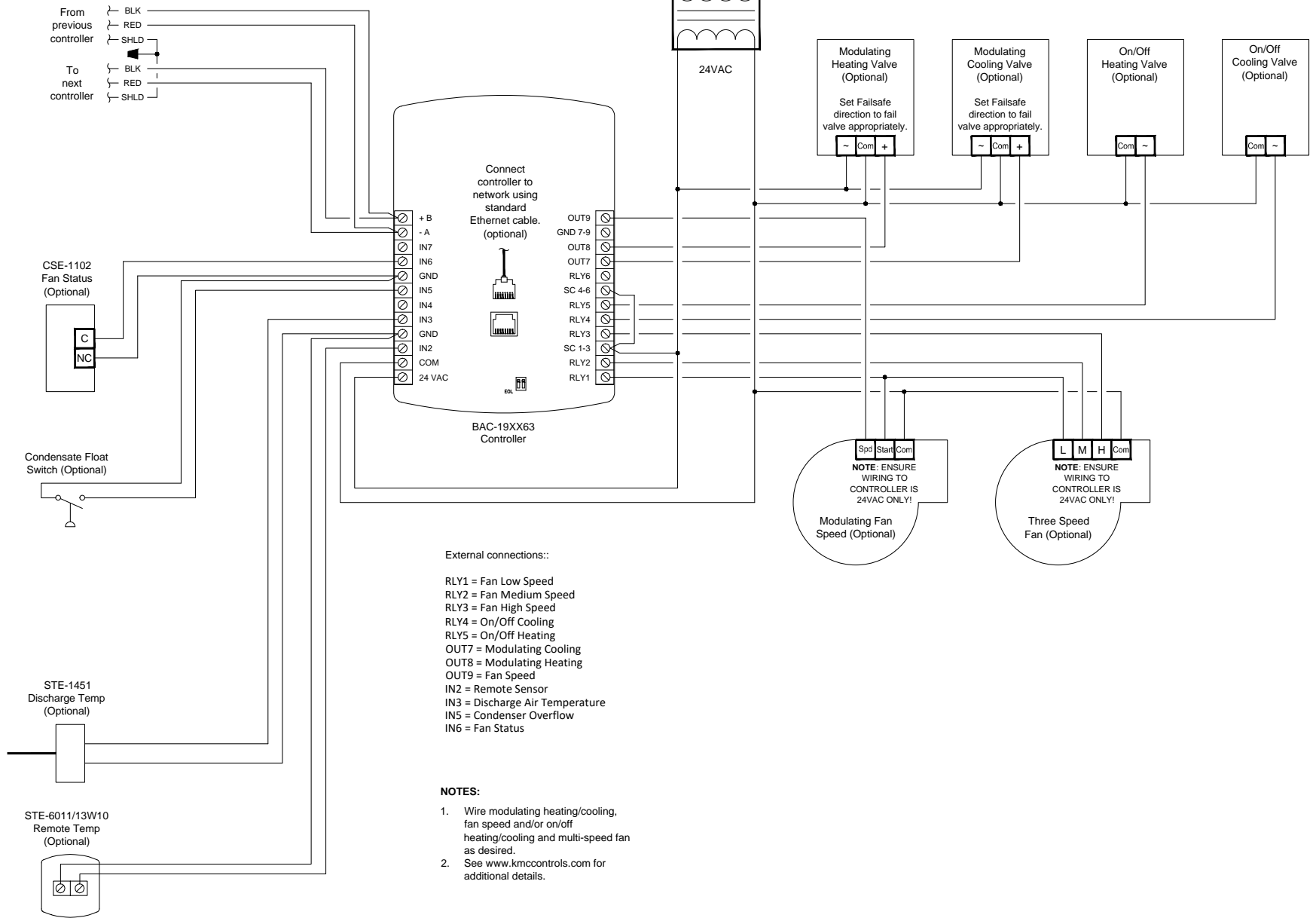



**4-Pipe Fan Coil Unit with Modulating and 3-Speed Fan,
Modulating and On/Off Valves and Humidity,
Motion and CO2 Sensors
Model: BAC-19xx63C(E)**

SEQUENCE OF OPERATION:

- Occupancy: The occupancy mode follows the internal schedule. If motion (optional) is not sensed within the standby timer during occupied mode, the unit goes into standby mode until motion is sensed again.
- 3 Speed fan: When the fan mode is set to *Auto* and either valve is called for, the fan starts on low speed. As the space temperature deviates further from setpoint, the fan speed changes to medium. As the space temperature passes the active setpoint plus/minus its span, high fan speed becomes the active speed. As the space temperature begins to return to setpoint, the active fan speed drops to medium. As the space temp further returns to setpoint, the fan speed switches to low. As the active valve closes, all fan speeds are deenergized. During the occupied and standby modes, low fan speed is energized while both valves are closed if the fan mode is set to *On*. The fan follows the normal sequence above once either valve opens.
- Modulating fan: When the fan mode is set to *Auto* and either valve opens, the fan starts at minimum fan speed. Once the active valve is fully open, as the space temperature deviates further from setpoint, the fan speed increases until it reaches maximum fan speed. As the space temperature begins to return to setpoint, the fan speed modulates toward minimum fan speed. The fan runs at minimum speed until the space temp further returns to setpoint and the active valve closes. During the occupied and standby modes, the fan is energized at minimum fan speed while both valves are closed if the fan mode is set to *On*. The fan follows the normal sequence above once either valve opens.

- When the fan starts at any speed, if the normally closed fan status switch (optional) doesn't open within 10 seconds, all heating and cooling outputs are deenergized. The fan output remains enabled and heating/cooling outputs remain disabled until the fan status switch opens.
- On/off valves: On a call for heating or cooling, the appropriate valve opens once the space temperature is more than half the span away from the setpoint. When the space temperature is within 5% of the span of setpoint, the opened valve closes.
- Modulating valves: As space temperature deviates from setpoint, the appropriate heating or cooling valve modulates open until it is 100% open when the space temp is 50% of the span away from setpoint. As the temperature drops within 50% of the span of setpoint, the heating or cooling valve modulates to closed.
- If the space humidity (optional) rises above the dehumidification setpoint, the cooling valve is opened 100%. The heating valve then follows its normal operation to maintain the *COOLING* setpoint. Once the space humidity drops below the dehumidification setpoint minus its span, dehumidification ceases and the heating and cooling valves resume normal operation.

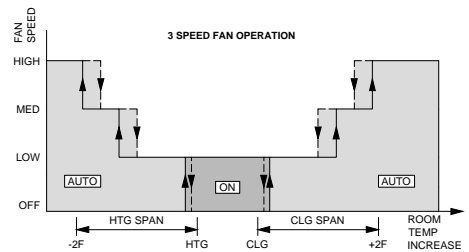
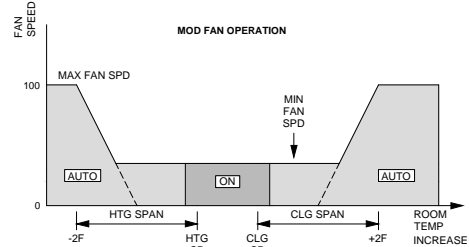
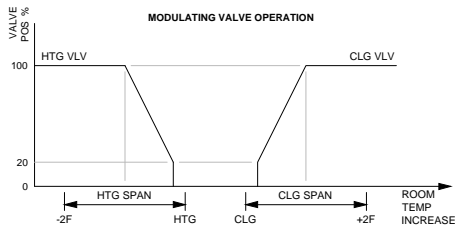
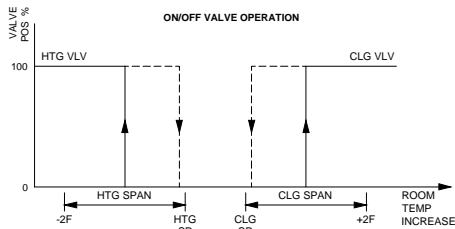
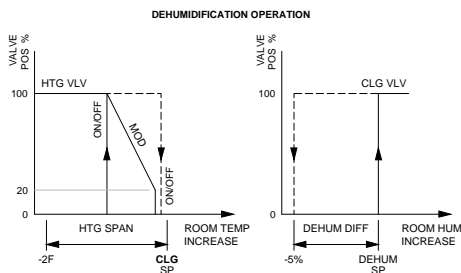

(4-PIPE) UNIT VENTILATOR (BAC-19XX36)

Inputs and Outputs List

(4-PIPE) UNIT VENTILATOR	
Inputs	
(A11)	INTERNAL Space Temperature Sensor*
AI2/IN2	Remote Room Temp. Sensor
AI3/IN3	Discharge Air Temperature
AI4/IN4	Outside Air Temperature
BI5/IN5	Condensate Overflow (Float Switch)
BI6/IN6	Fan Status
BI7/IN7	Low Limit Status
(A18)	INTERNAL Humidity Sensor*
(BI9)	INTERNAL Motion Sensor*
(A110)	INTERNAL CO2 Sensor*
*Internal temperature sensor is on all models. Optional internal humidity, motion, and CO2 sensors are on applicable models.	
Outputs	
BO1/RLY1	3-Speed Fan Low Speed; Mod. Fan Start
BO2/RLY2	3-Speed Fan Medium Speed
BO3/RLY3	3-Speed Fan High Speed
AO4/OUT4	Analog Output #4
AO5/OUT5	Analog Output #5
AO6/OUT6	Modulating Fan Speed Control
AO7/OUT7	Modulating Cooling Valve
AO8/OUT8	Modulating Heating Valve
AO9/OUT9	Outdoor Air Damper

NOTE: For **Fan Coil Unit** applications (no outside air damper), see **(2-Pipe and 4-Pipe) Fan Coil Unit (BAC-19xx63)** on page 7.

NOTE: See also **DCV (Demand Control Ventilation)** on page 3.

NOTE: Binary Output (BO1–BO3) terminals are relays and are used with SC terminals instead of GND terminals.

NOTE: Universal (analog) inputs (AIx/INx) and outputs (AOx/OUTx) are used with GND terminals. They can be configured to emulate binary (on/off or voltage/no-voltage) objects.

NOTE: Universal Input (INx) terminal = Analog Input (AIx) object or Binary Input (BIx). Universal Output (OUTx) terminal = Analog Output (AOx) object. Relay output (RLYx) = Binary Output (BOx) object.

NOTE: Unused inputs and outputs are available for use with custom configuration and programming in KMC software.

4-Pipe Unit Ventilator with Modulating and 3-Speed Fan, Modulating Valves, Outside Air Damper and Humidity, Motion and CO2 Sensors Model: BAC-19xx36C(E)

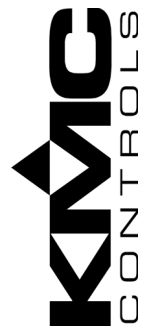

If controllers are to be networked together via MS/TP, turn **ON** EOL switch on the controllers at both physical ends of the network. Connect shield wires together and to earth ground at only one point, but do not connect to controllers.

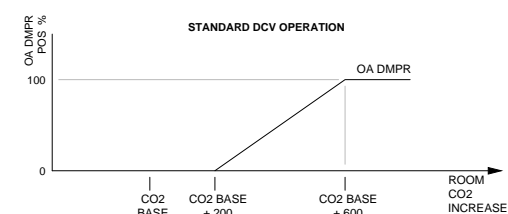
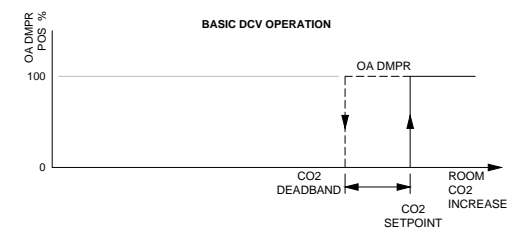
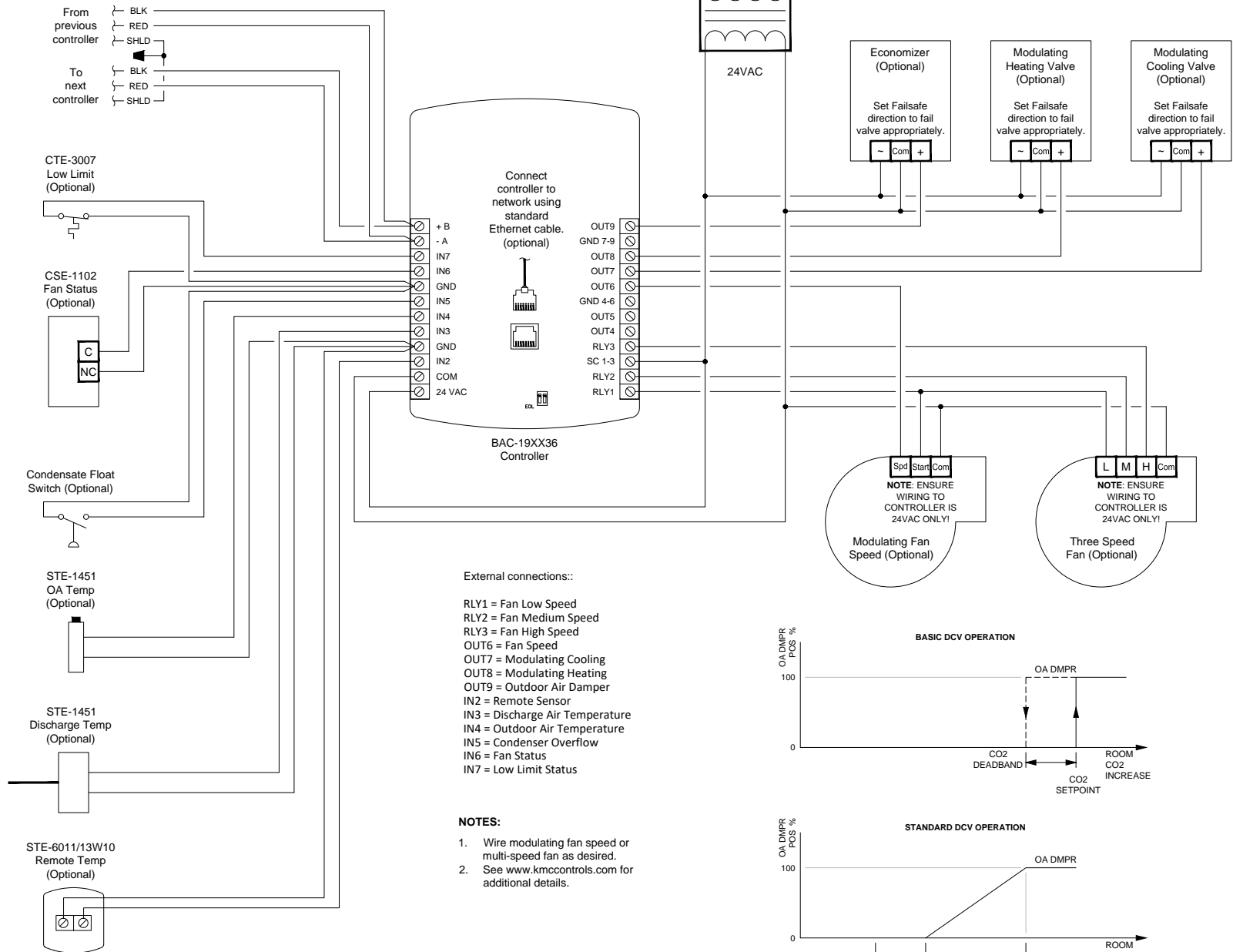

SEQUENCE OF OPERATION:

1. Occupancy: The occupancy mode follows the internal schedule. If motion (optional) is not sensed within the standby timer during occupied mode, the unit goes into standby mode until motion is sensed again.
2. 3 Speed fan: When the fan mode is set to *Auto* and either valve or economizer is called for, the fan starts on low speed. As the space temperature deviates further from setpoint, the fan speed changes to medium. As the space temperature passes the active setpoint plus/minus its span, high fan speed becomes the active speed. As the space temperature begins to return to setpoint, the active fan speed drops to medium. As the space temp further returns to setpoint, the fan speed switches to low. As the active valve closes and there is no call for economizer, all fan speeds are deenergized. During the occupied and standby modes, low fan speed is energized while both valves are closed if the fan mode is set to *On*. The fan follows the normal sequence above once either valve opens.
3. Modulating fan: When the fan mode is set to *Auto* and either valve opens or there is a call for economizer, the fan starts at minimum fan speed. Once the active valve or economizer is fully open, as the space temperature deviates further from setpoint, the fan speed increases until it reaches maximum fan speed. As the space temperature begins to return to setpoint, the fan speed modulates toward minimum fan speed. The fan runs at minimum speed until the space temp further returns to setpoint and the active valve or economizer closes. During the occupied and standby modes, the fan is energized at minimum fan speed while both valves and economizer are closed if the fan mode is set to *On*. The fan follows the normal sequence above once either valve or the economizer opens.
4. When the fan starts at any speed, if the normally closed fan status switch (optional) doesn't open within 10 seconds, all heating and

5. cooling outputs are deenergized. The fan output remains enabled and heating/cooling outputs remain disabled until the fan status switch opens.
5. Modulating valves: As space temperature deviates from setpoint, the appropriate heating or cooling valve modulates open until it is 100% open when the space temp is 50% of the span away from setpoint. As the temperature drops within 50% of the span of setpoint, the heating or cooling valve modulates to closed.
8. Economizer: During occupied mode, if outside air temp (OAT) drops below the economizer enable temp and there is a call for cooling, econ mode is enabled. Econ mode is disabled if OAT rises 1 deg above the econ enable temp. While economizing, the outside air damper (OAD) modulates to maintain discharge air temp (DAT). As space temp rises above the cooling setpoint, DAT setpoint resets from the space temp to the minimum DAT. While economizing, the OAD is open to the greater of the minimum damper position or DAT control. The OAD is shut during unoccupied mode and any time the fan is off.
9. If the space humidity (optional) rises above the dehumidification setpoint, the cooling valve is opened 100%. The heating valve then follows its normal operation to maintain the *COOLING* setpoint. Once the space humidity drops below the dehumidification setpoint minus its span, dehumidification ceases and the heating and cooling valves resume normal operation.
10. In Basic Demand Control Ventilation (DCV), the OA damper opens 100% as the CO2 level rises above the CO2 setpoint. As the CO2 level drops below the CO2 setpoint minus the CO2 deadband, the damper relinquishes to previous control.
11. In Standard DCV, the OA damper modulates from 0% open as the CO2 level rises from the CO2 base level +200 ppm to 100% open at the CO2 base level +600 ppm.
13. When both CO2 and economizer control are enabled, the damper responds to the greater of CO2 or economizer control.

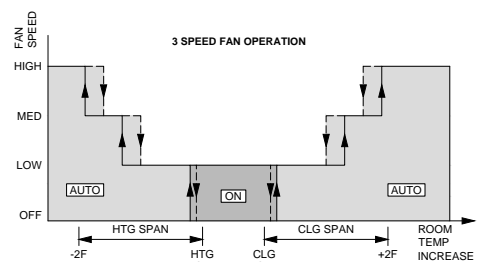
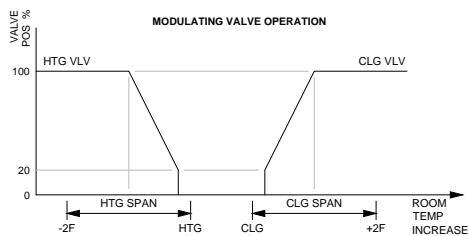
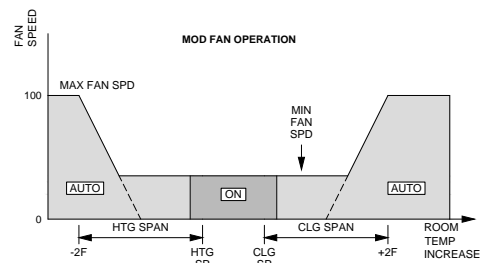
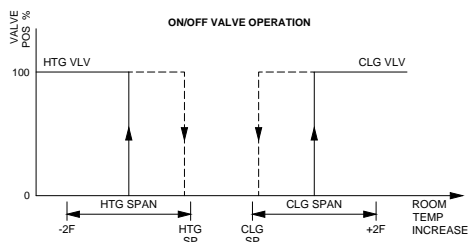
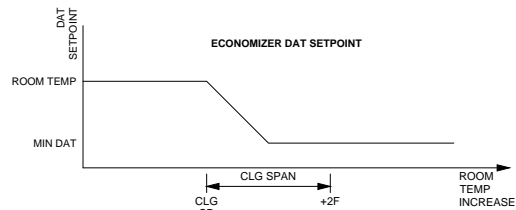
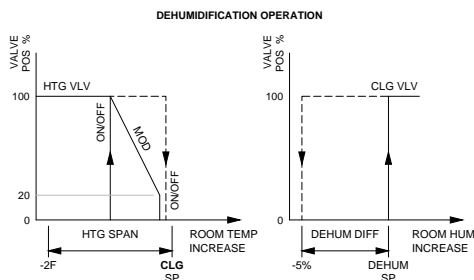

HEAT PUMP UNIT (BAC-19XX63)

Inputs and Outputs List

HPU	
Inputs	
(AI1)	INTERNAL Space Temperature Sensor*
AI2/IN2	Remote Room Temp. Sensor
AI3/IN3	Discharge Air Temperature
AI4/IN4	Outside Air Temperature
BI5/IN5	
BI6/IN6	Fan Status
AI7/IN7	Analog Input #7
(AI8)	INTERNAL Humidity Sensor*
(BI9)	INTERNAL Motion Sensor*
(AI10)	INTERNAL CO2 Sensor*
*Internal temperature sensor is on all models. Optional internal humidity, motion, and CO2 sensors are on applicable models.	
Outputs	
BO1/RLY1	Fan Start - Stop
BO2/RLY2	Stage 1 Compressor
BO3/RLY3	Stage 2 Compressor
BO4/RLY4	Reversing Valve
BO5/RLY5	Auxiliary Heat
BO6/RLY6	Binary Output #6
AO7/OUT7	Analog Output #7
AO8/OUT8	Analog Output #8
AO9/OUT9	Economizer Output

NOTE: Binary Output (BO1–BO6) terminals are relays and are used with SC terminals instead of GND terminals.

NOTE: Universal (analog) inputs (AIx/INx) and outputs (AOx/OUTx) are used with GND terminals. They can be configured to emulate binary (on/off or voltage/no-voltage) objects.

NOTE: Universal Input (INx) terminal = Analog Input (AIx) object or Binary Input (BIx). Universal Output (OUTx) terminal = Analog Output (AOx) object. Relay output (RLYx) = Binary Output (BOx) object.

NOTE: Unused inputs and outputs are available for use with custom configuration and programming in KMC software.

Heat Pump Unit with Auxiliary Heat, Economizer, and Humidity, Motion and CO2 Sensors

Model: BAC-19xx63C(E)



If controllers are to be networked together via MS/TP, turn **ON** EOL switch on the controllers at both physical ends of the network. Connect shield wires together and to earth ground at only one point, but do not connect to controllers.

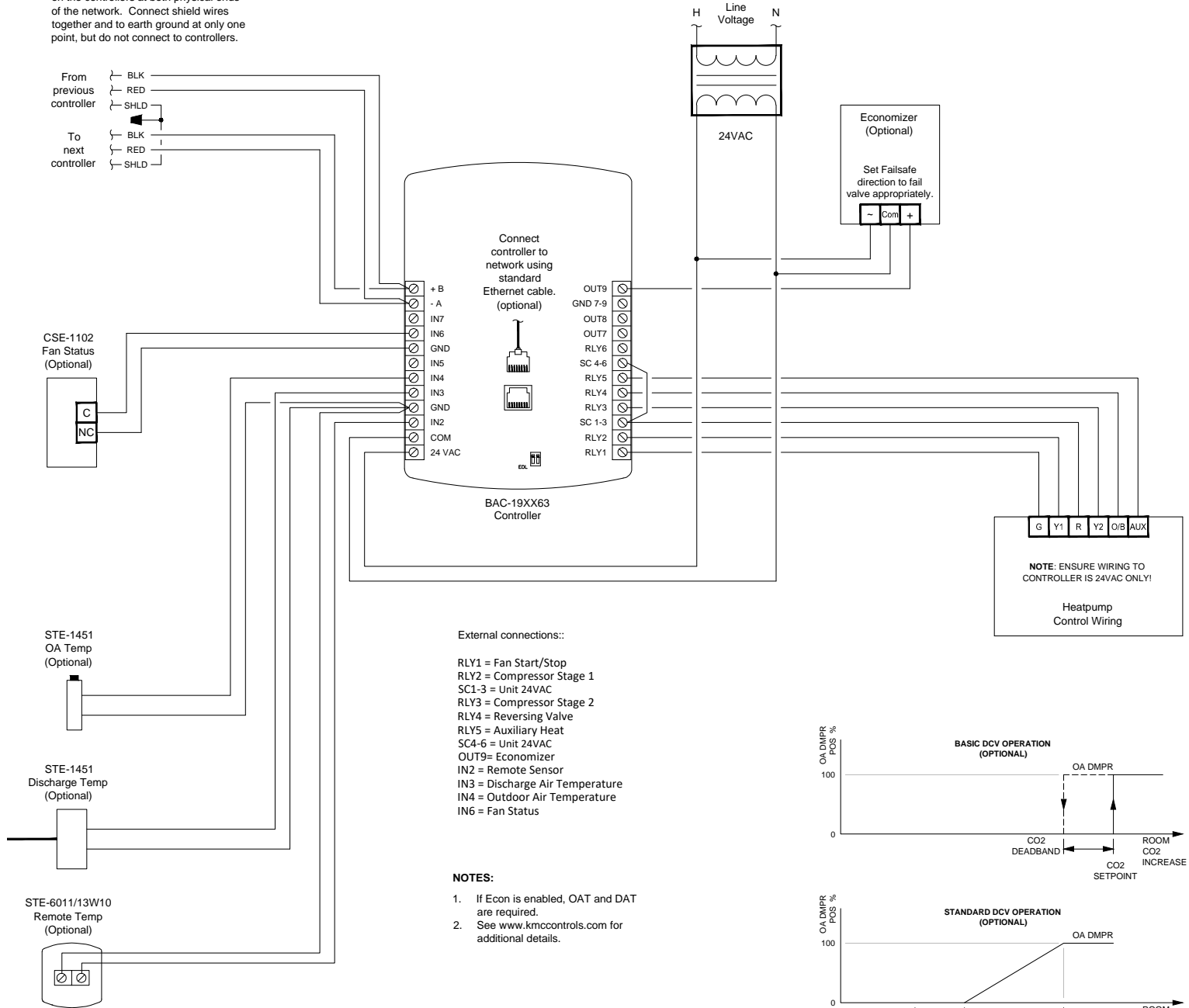

External connections::

- RLY1 = Fan Start/Stop
- RLY2 = Compressor Stage 1
- SC1-3 = Unit 24VAC
- RLY3 = Compressor Stage 2
- RLY4 = Reversing Valve
- RLY5 = Auxiliary Heat
- SC4-6 = Unit 24VAC
- OUT9= Economizer
- IN2 = Remote Sensor
- IN3 = Discharge Air Temperature
- IN4 = Outdoor Air Temperature
- IN6 = Fan Status

NOTES:

1. If Econ is enabled, OAT and DAT are required.
2. See www.kmcccontrols.com for additional details.

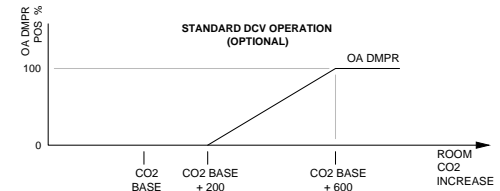
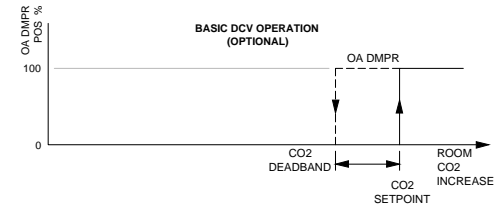



Heat Pump Unit with Auxiliary Heat, Economizer, and Humidity, Motion and CO2 Sensors

Model: BAC-19xx63C(E)

SEQUENCE OF OPERATION:

1. Occupancy: The occupancy mode follows the internal schedule. If motion (optional) is not sensed within the standby timer during occupied mode, the unit goes into standby mode until motion is sensed again.
2. On/off fan: When the fan mode is set to *Auto* and heating (any form), cooling or economizer is called for, the fan starts. Once the space temp returns to setpoint, there is no call for any heating, cooling nor economizer and the fan-off-delay expires (2 minutes), the fan shuts off. During the occupied and standby modes, the fan output is energized any time the fan mode is set to *On*.
3. When the fan starts, if the normally closed fan status switch (optional) doesn't open within 10 seconds, all heating, cooling and economizer outputs are deenergized. The fan output remains enabled and heating/cooling/economizer outputs remain disabled until the fan status switch opens.
4. Reversing valve: The reversing valve output is energized on a call for cooling (adjustable).
6. Cooling: As space temp rises above the cooling setpoint plus the cooling span, compressor 1 is energized if the minimum off time has been met. If the space temp remains above the cooling setpoint plus the cooling span for the stage delay, compressor 2 is energized after ensuring its minimum off time. As the space temp drops below half of the cooling span above the cooling setpoint, compressor 2 is deenergized. As the space temp drops below the cooling setpoint, compressor 1 is deenergized.
7. Compressor heating: As space temp drops below the heating setpoint minus the heating span, compressor 1 is energized if the minimum off time has been met. If the space temp remains below the heating setpoint minus the heating span for the stage delay, compressor 2 is energized after ensuring its minimum off time. As the space temp rises above half of the heating span below heating setpoint, compressor 2 is deenergized. As the space temp rises above the heating setpoint, compressor 1 is deenergized.
8. Auxiliary heat/third stage: When auxiliary heat is configured for *Third Stage*, the unit is in heating mode and compressor 2 has been on for the stage delay, the aux heat output is energized. As the space temp rises above 65% of the heating span below heating setpoint, aux heat is deenergized.

9. Auxiliary heat/compressor lockout: When auxiliary heat is configured for *Comp Lockout*, both compressors are locked out and the auxiliary heat output follows the compressor 1 heating sequence.
10. Emergency heat: When the system mode is manually set to *Emergency Heat*, all outputs besides fan are locked out and aux heat is energized as space temp drops below heating setpoint minus heating span. As the space temp rises above the heating setpoint, the aux heat output is deenergized.
11. Economizer: During occupied mode, if outside air temp (OAT) drops below the economizer enable temp and there is a call for cooling, econ mode is enabled. Econ mode is disabled if OAT rises 1 deg above the econ enable temp. While economizing, the outside air damper (OAD) modulates to maintain discharge air temp (DAT). As space temp rises above the cooling setpoint, DAT setpoint resets from the space temp to the minimum DAT. While economizing, the OAD is open to the greater of the minimum damper position or DAT control. The OAD is shut during unoccupied mode and any time the fan is off.
12. If the space humidity (optional) rises above the dehumidification setpoint, compressor 1 is energized if the minimum off time has been met. If the humidity remains high for the stage delay and compressor 2's minimum off time has been met, compressor 2 is energized. Auxiliary heat is then cycled to maintain the *COOLING* setpoint. Once the space humidity drops below the dehumidification setpoint minus its span, dehumidification ceases and the compressors resume normal space temp control.
13. In Basic Demand Control Ventilation (DCV), the OA damper opens 100% as the CO2 level rises above the CO2 setpoint. As the CO2 level drops below the CO2 setpoint minus the CO2 deadband, the damper relinquishes to previous control.
14. In Standard DCV, the OA damper modulates from 0% open as the CO2 level rises from the CO2 base level +200 ppm to 100% open at the CO2 base level +600 ppm.
15. When both CO2 and economizer control are enabled, the damper responds to the greater of CO2 or economizer control.

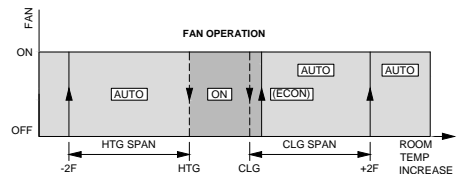
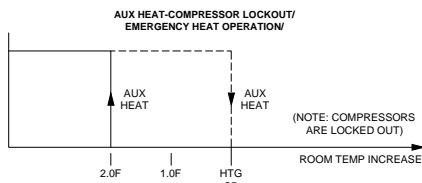
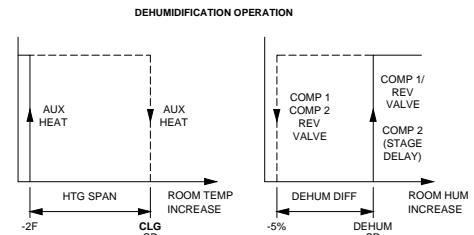
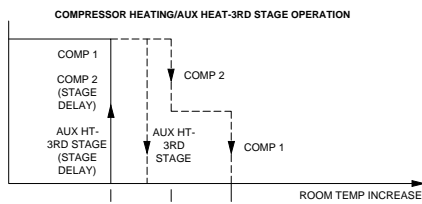
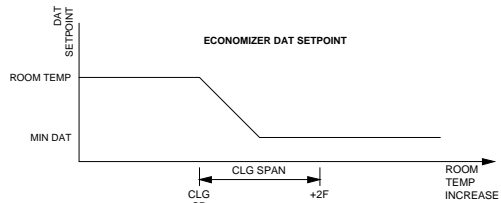
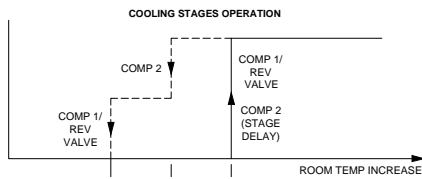

ROOF TOP UNIT (BAC-19XX63)

Inputs and Outputs List

RTU	
Inputs	
(AI1)	INTERNAL Space Temperature Sensor*
AI2/IN2	Remote Room Temp. Sensor
AI3/IN3	Discharge Air Temperature
AI4/IN4	Outside Air Temperature
AI5/IN5	Analog Input #5
BI6/IN6	Fan Status
AI7/IN7	Analog Input #7
(AI8)	INTERNAL Humidity Sensor*
(BI9)	INTERNAL Motion Sensor*
(AI10)	INTERNAL CO2 Sensor*
*Internal temperature sensor is on all models. Optional internal humidity, motion, and CO2 sensors are on applicable models.	
Outputs	
BO1/RLY1	Fan Start - Stop
BO2/RLY2	Stage 1 Cooling*
BO3/RLY3	Stage 2 Cooling
BO4/RLY4	Binary Output #4
BO5/RLY5	Stage 1 Heating*
BO6/RLY6	Stage 2 Heating
AO7/OUT7	Analog Cooling Output*
AO8/OUT8	Analog Heating Output*
AO9/OUT9	Economizer Output
*AO7 and BO2 are controlled simultaneously.	
**AO8 and BO5 are controlled simultaneously.	

NOTE: See also **DCV (Demand Control Ventilation)** on page 3.

NOTE: Binary Output (BO1–BO6) terminals are relays and are used with SC terminals instead of GND terminals.

NOTE: Universal (analog) inputs (AIx/INx) and outputs (AOx/OUTx) are used with GND terminals. They can be configured to emulate binary (on/off or voltage/no-voltage) objects.

NOTE: Universal Input (INx) terminal = Analog Input (AIx) object or Binary Input (BIx). Universal Output (OUTx) terminal = Analog Output (AOx) object. Relay output (RLYx) = Binary Output (BOx) object.

NOTE: Unused inputs and outputs are available for use with custom configuration and programming in KMC software.

Roof Top Unit with On/Off Fan, Modulating and 2-Stage Heating and Cooling, Economizer, and Humidity, Motion and CO2 Sensors Model: BAC-19xx63C(E)



If controllers are to be networked together via MS/TP, turn **ON** EOL switch on the controllers at both physical ends of the network. Connect shield wires together and to earth ground at only one point, but do not connect to controllers.

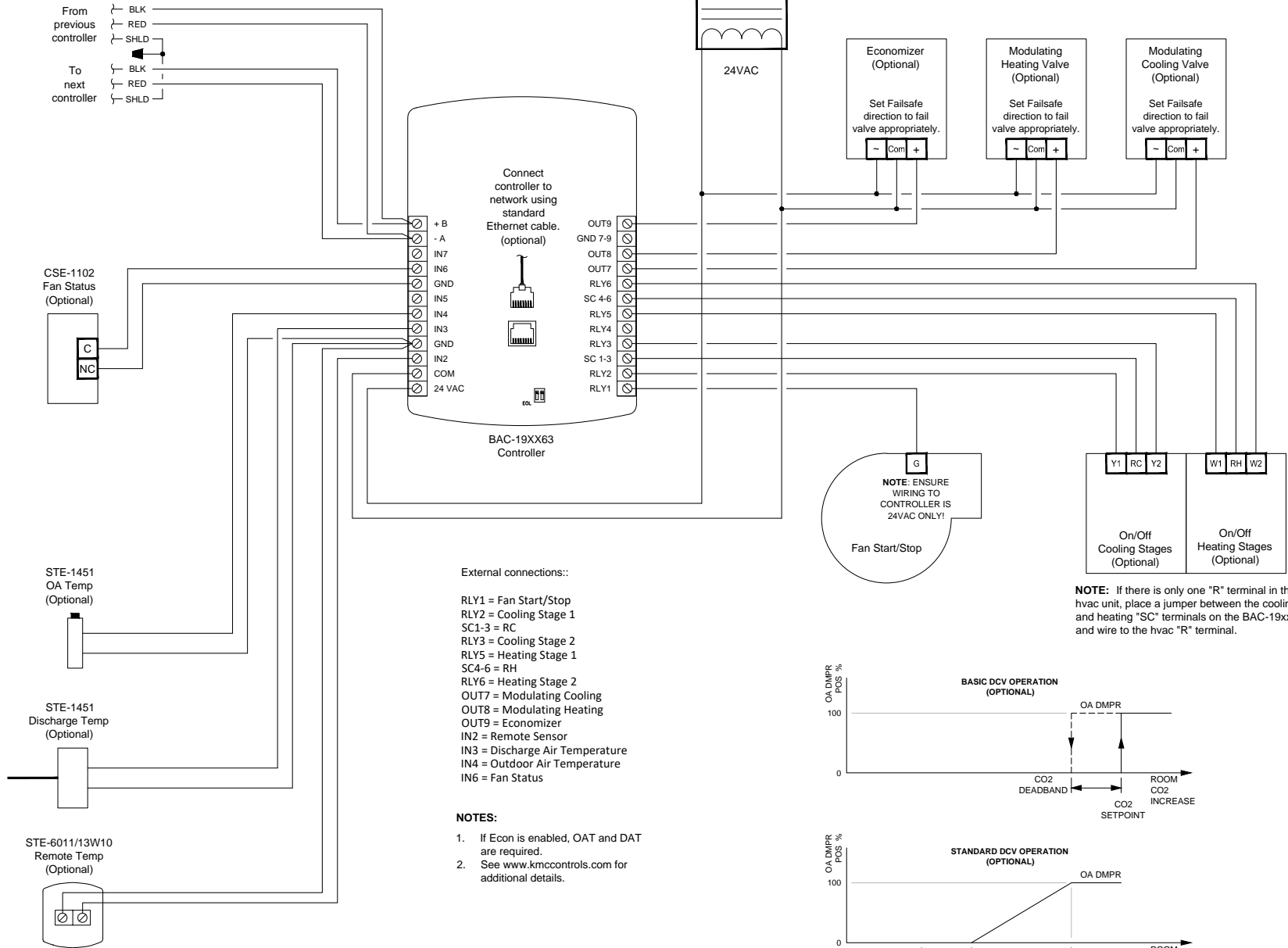

External connections::

- RLY1 = Fan Start/Stop
- RLY2 = Cooling Stage 1
- SC1-3 = RC
- RLY3 = Cooling Stage 2
- RLY5 = Heating Stage 1
- SC4-6 = RH
- RLY6 = Heating Stage 2
- OUT7 = Modulating Cooling
- OUT8 = Modulating Heating
- OUT9 = Economizer
- IN2 = Remote Sensor
- IN3 = Discharge Air Temperature
- IN4 = Outdoor Air Temperature
- IN6 = Fan Status

NOTES:

1. If Econ is enabled, OAT and DAT are required.
2. See www.kmccontrols.com for additional details.

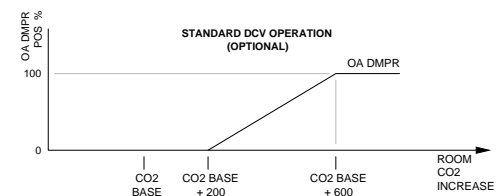
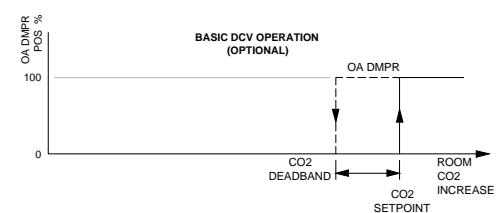
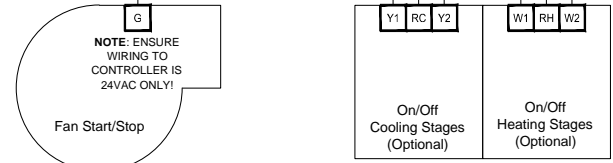

NOTE: If there is only one "R" terminal in the hvac unit, place a jumper between the cooling and heating "SC" terminals on the BAC-19xx63 and wire to the hvac "R" terminal.



**Roof Top Unit with On/Off Fan,
Modulating and 2-Stage Heating and Cooling,
Economizer, and Humidity, Motion and CO2 Sensors
Model: BAC-19xx63C(E)**

SEQUENCE OF OPERATION:

1. Occupancy: The occupancy mode follows the internal schedule. If motion (optional) is not sensed within the standby timer during occupied mode, the unit goes into standby mode until motion is sensed again.
2. On/off fan: When the fan mode is set to *Auto* and heating, cooling or economizer is called for, the fan starts. Once the space temp returns to setpoint, there is no call for heating, cooling nor economizer and the fan-off-delay expires (2 minutes), the fan shuts off. During the occupied and standby modes, the fan output is energized any time the fan mode is set to *On*.
3. When the fan starts, if the normally closed fan status switch (optional) doesn't open within 10 seconds, all heating, cooling and economizer outputs are deenergized. The fan output remains enabled and heating/cooling/economizer outputs remain disabled until the fan status switch opens.
4. Modulating heating: As space temp drops below the heating setpoint, the heating valve modulates open. As the space temp rises toward the heating setpoint, the heating valve modulates closed. If the fan is set to *Auto*, the valve is held shut until the space temp drops below the heating setpoint minus the heating span at which point the valve opens and follows the normal sequence.
5. Modulating Cooling: As space temp rises above the cooling setpoint, the cooling valve modulates open. As the space temp drops toward the cooling setpoint, the cooling valve modulates closed. While economizing, the cooling valve is held shut the first 50% of the cooling span above the cooling setpoint and then modulates open. If the fan is set to *Auto*, the valve is held shut until the space temp rises above the cooling setpoint plus the cooling span at which point the valve opens and follows the normal sequence.
6. Staged heating: As space temp drops below the heating setpoint minus the heating span, heating stage 1 is energized. If the space temp remains below the heating setpoint minus the heating span for the stage delay, heating stage 2 is energized. As the space temp rises above half of the heating span below heating setpoint, stage 2 heating is deenergized. As the space temp rises above the heating setpoint, heating stage 1 is deenergized.
7. Staged cooling: As space temp rises above the cooling setpoint plus the cooling span, cooling stage 1 is energized if the minimum off time has been met. If the space temp remains above the cooling setpoint plus the cooling span for the stage delay, cooling stage 2 is energized after

- ensuring its minimum off time. As the space temp drops below half of the cooling span above cooling setpoint, stage 2 cooling is deenergized. As the space temp drops below the cooling setpoint, cooling stage 1 is deenergized.
8. Economizer: During occupied mode, if outside air temp (OAT) drops below the economizer enable temp and there is a call for cooling, econ mode is enabled. Econ mode is disabled if OAT rises 1 deg above the econ enable temp. While economizing, the outside air damper (OAD) modulates to maintain discharge air temp (DAT). As space temp rises above the cooling setpoint, DAT setpoint resets from the space temp to the minimum DAT. While economizing, the OAD is open to the greater of the minimum damper position or DAT control. The OAD is shut during unoccupied mode and any time the fan is off.
 9. If the space humidity (optional) rises above the dehumidification setpoint, the cooling valve is opened 100%. Cooling stage 1 is energized if the minimum off time has been met. If the humidity remains high for the stage delay and cooling stage 2's minimum off time has been met, cooling stage 2 is energized. The heating valve and staging then follows their normal operation to maintain the *COOLING* setpoint. Once the space humidity drops below the dehumidification setpoint minus its span, dehumidification ceases and the heating and cooling valves and staging resume normal operation.
 10. In Basic Demand Control Ventilation (DCV), the OA damper opens 100% as the CO2 level rises above the CO2 setpoint. As the CO2 level drops below the CO2 setpoint minus the CO2 deadband, the damper relinquishes to previous control.
 11. In Standard DCV, the OA damper modulates from 0% open as the CO2 level rises from the CO2 base level +200 ppm to 100% open at the CO2 base level +600 ppm.
 12. When both CO2 and economizer control are enabled, the damper responds to the greater of CO2 or economizer control.

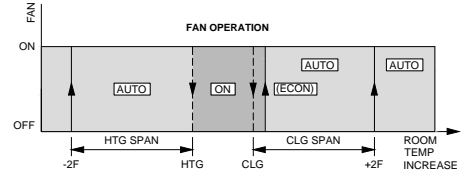
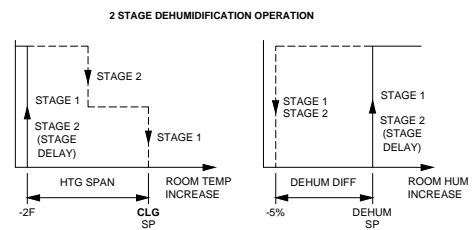
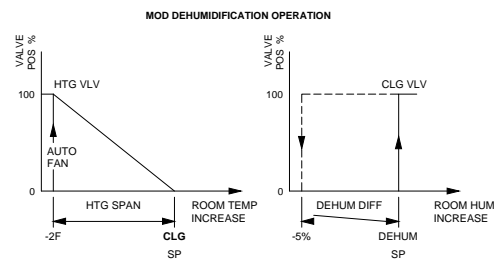
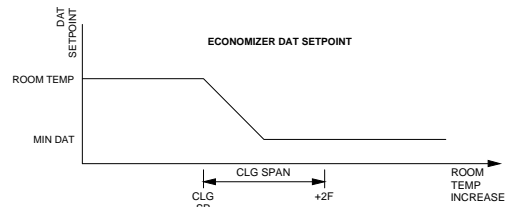
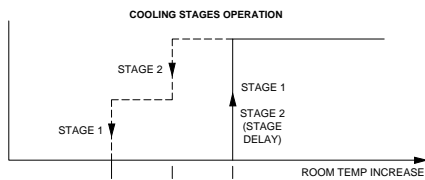
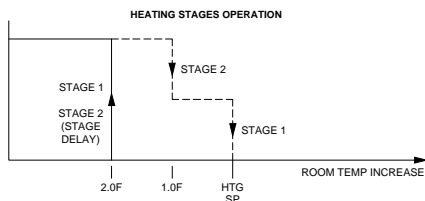
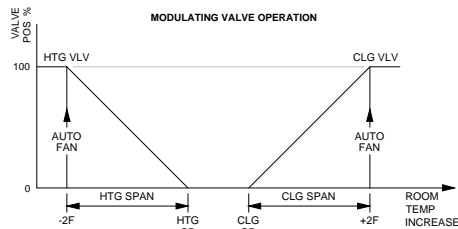

IMPORTANT NOTICES

NOTE: This device complies with Part 15 of the FCC Rules. Operation is subject to the following two conditions: (1) this device may not cause harmful interference, and (2) this device must accept any interference received, including interference that may cause undesired operation. A BAC-19xxxx Class A digital apparatus complies with Canadian ICES-003.

KMC Controls® and KMC Commander® are all registered trademarks of KMC Controls. FlexStat™, KMC Conquest™, KMC Connect™, KMC Converge™, and TotalControl™ are all trademarks of KMC Controls. All other products or name brands mentioned are trademarks of their respective companies or organizations.

All rights reserved. No part of this publication may be reproduced, transmitted, transcribed, stored in a retrieval system, or translated into any language in any form by any means without the written permission of KMC Controls, Inc.

The material in this document is for information purposes only. **The contents and the product it describes are subject to change without notice.** KMC Controls, Inc. makes no representations or warranties with respect to this document. In no event shall KMC Controls, Inc. be liable for any damages, direct or incidental, arising out of or related to the use of this document.

Specifications and design are subject to change without notice.

SUPPORT

Additional KMC product information and resources are available on the web at www.kmccontrols.com. Log in to see all available files.

