



## Contents

<b>Example Diagrams .....</b>	<b>2</b>		
<b>Standard Application .....</b>	<b>2</b>		
<b>Outdoor Air Damper Pressure Assist Application ..</b>	<b>2</b>		
<b>Return Air Damper Pressure Assist Application ....</b>	<b>3</b>		
<b>Mounting the System Components .....</b>	<b>4</b>		
<b>Mounting the Controller .....</b>	<b>4</b>		
<b>Mounting the Inclinator .....</b>	<b>5</b>		
<b>Mounting the Supply Airflow Pickup Tubes .....</b>	<b>6</b>		
<b>Mounting Pickup Tubes for Pressure Assist .....</b>	<b>8</b>		
<b>Mounting the Pressure Transducer(s) .....</b>	<b>10</b>		
<b>Mounting the OAT, RAT, and MAT Sensors .....</b>	<b>11</b>		
<b>Mounting a Proportional Actuator .....</b>	<b>13</b>		
<b>Connecting System Components to the Controller ....</b>	<b>14</b>		
<b>Connecting the Airflow Pickup Tubes .....</b>	<b>14</b>		
<b>Connecting the Inclinator .....</b>	<b>15</b>		
<b>Connecting the Outside Air Temperature Sensor ..</b>	<b>15</b>		
<b>Connecting the Return Air Temperature Sensor ..</b>	<b>16</b>		
<b>Connecting the Mixed Air Temperature Sensor ...</b>	<b>16</b>		
<b>Connecting the Proportional Actuator .....</b>	<b>17</b>		
		<b>Connecting Networks .....</b>	<b>18</b>
		<b>Connecting an Ethernet Network .....</b>	<b>18</b>
		<b>Connecting an MS/TP Network .....</b>	<b>18</b>
		<b>Connecting Power .....</b>	<b>20</b>
		<b>Connecting Power to the Controller .....</b>	<b>20</b>
		<b>Connecting Power to the Inclinator .....</b>	<b>20</b>
		<b>Connecting Power to the Pressure Transducer(s) ..</b>	<b>20</b>
		<b>Connecting Power to the Proportional Actuator ..</b>	<b>21</b>
		<b>Controller Power and Communication Status .....</b>	<b>22</b>
		<b>Controller MS/TP Network Isolation Bulbs .....</b>	<b>23</b>
		<b>Wiring Diagrams .....</b>	<b>24</b>
		<b>Input/Output Objects/Connections .....</b>	<b>30</b>
		<b>Configuring and Operating .....</b>	<b>30</b>
		<b>Important Notices .....</b>	<b>31</b>



# Example Diagrams

## Standard Application

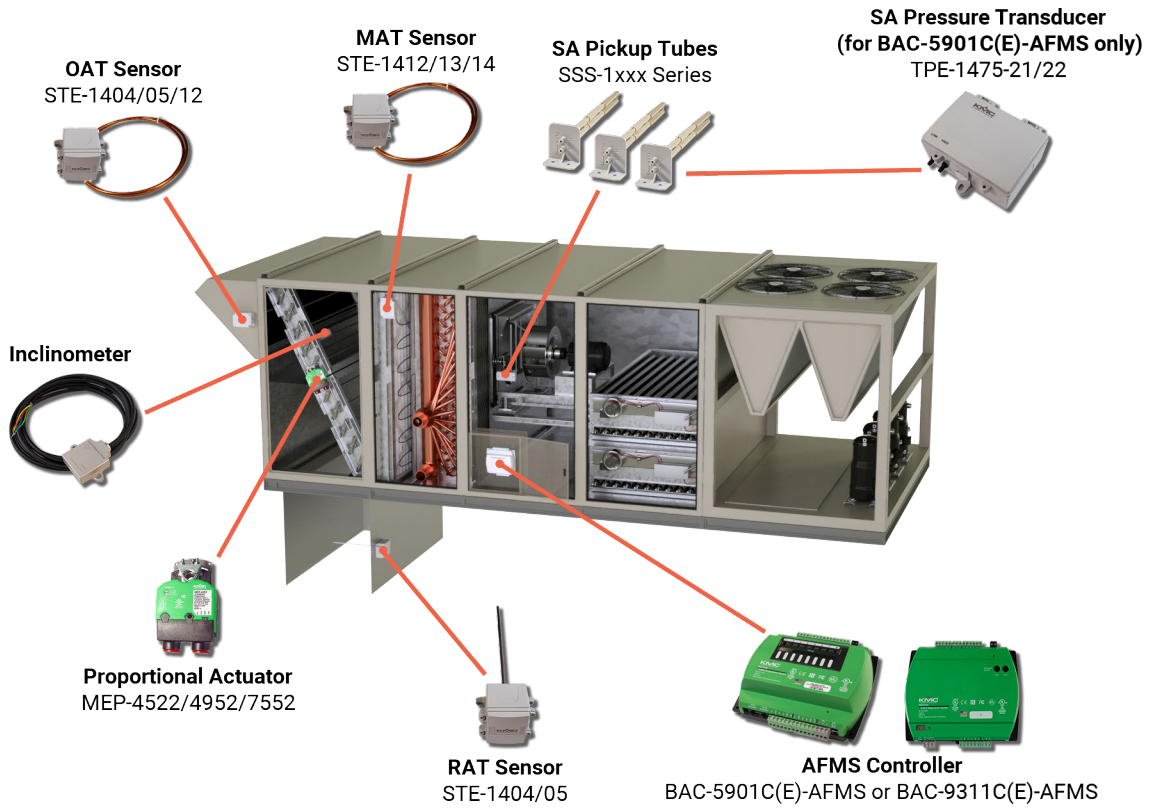

## Outdoor Air Damper Pressure Assist Application

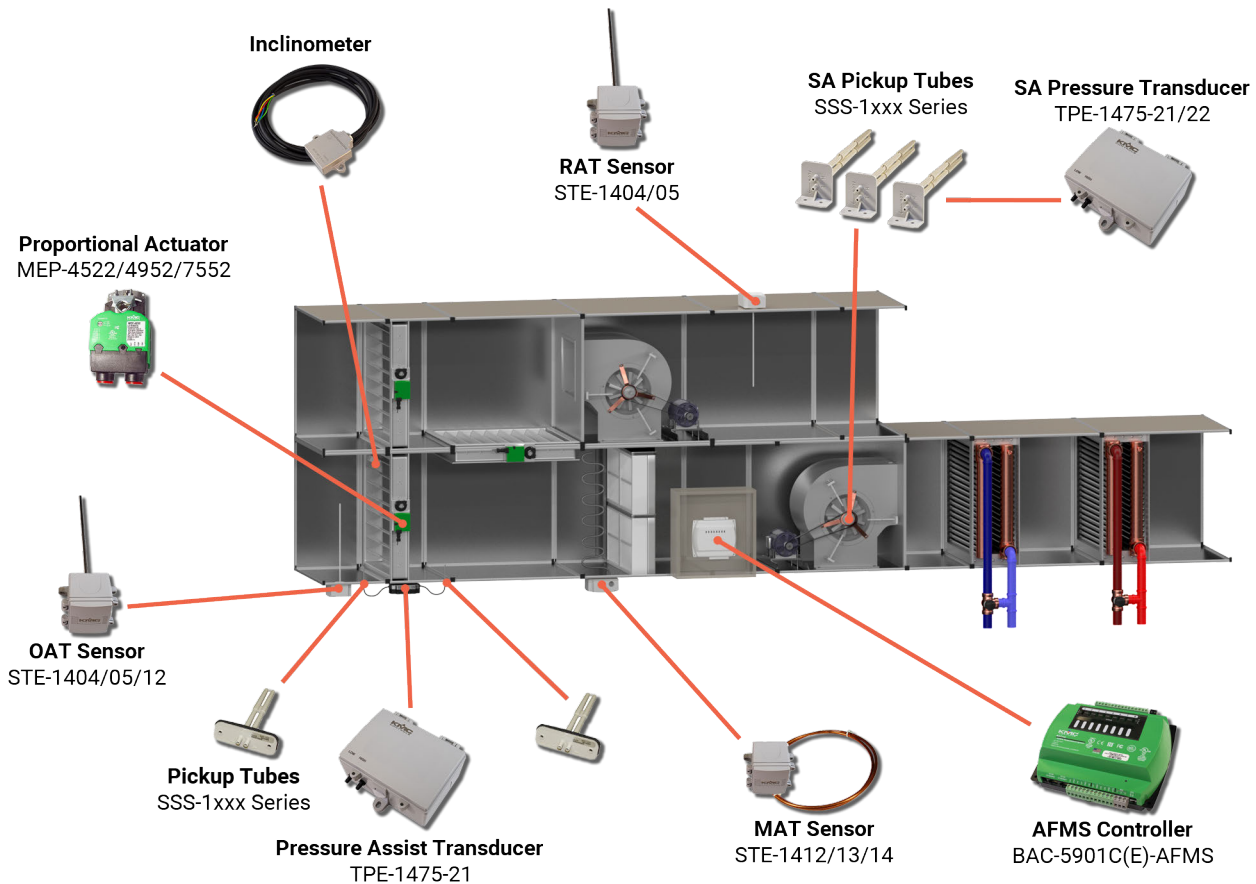

# Return Air Damper Pressure Assist Application

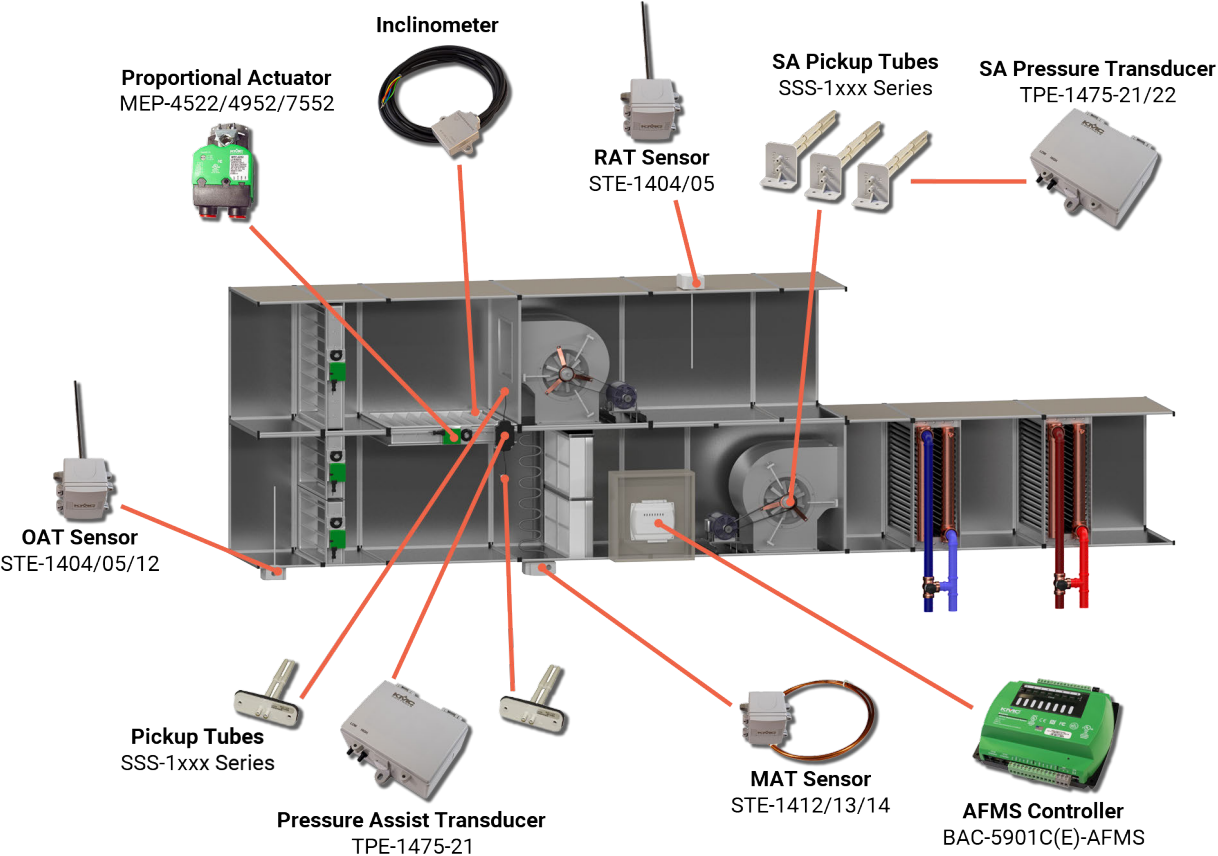

# Mounting the System Components

## Mounting the Controller

**NOTE:** Mount the controller inside a metal enclosure for RF shielding and physical protection.

**NOTE:** To mount the controller with **screws** on a flat surface, complete the steps in **On a Flat Surface** Or to mount the controller on a 35 mm **DIN rail** (such as integrated in an **HCO-1103** enclosure), complete the steps in **On a DIN Rail**.

### On a Flat Surface

1. Position the controller on a flat surface so that the color-coded **terminal blocks** **1** are easy to access for wiring after the controller is mounted.

**NOTE:** The black terminals are for power. The green terminals are for inputs and outputs. The grey terminals are for communication.

2. Screw a #6 sheet metal screw through each **corner** **2** of the controller.

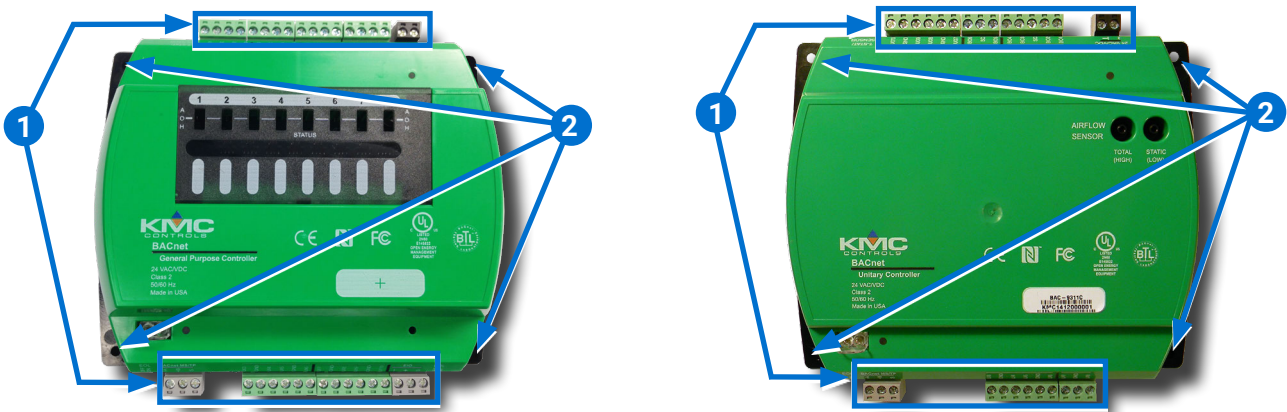

### On a DIN Rail

1. Position the **DIN rail** **3** so that the color-coded terminal blocks are easy to access for wiring after the controller is mounted.
2. Pull out the **DIN latch** **4** until it clicks once.
3. Position the controller so that the top **four tabs** **5** of the back channel rest on the DIN rail.

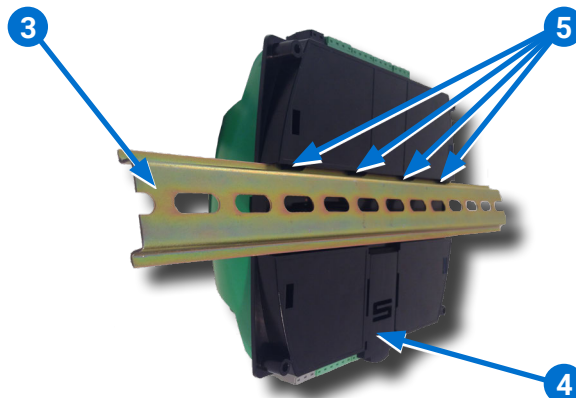

4. Lower the controller against the DIN rail.
5. Push in the **DIN latch** **6** to engage the rail.

**NOTE:** To remove the controller, pull the DIN latch until it clicks once and lift the controller off the DIN rail.

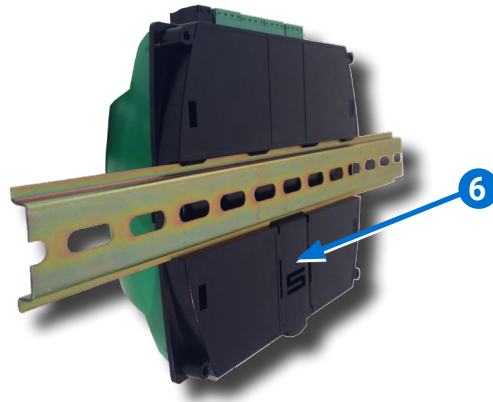

## Mounting the Inclinometer

**NOTE:** If the outside air damper has vertical-axis damper blades, you will first need to install an **HLO-1050 Linkage Kit** on the outside air damper. (See the *HLO-1050 Linkage Kit Installation Guide*.) Then continue below.

1. Position the inclinometer on a horizontal-axis outside air damper blade so that the wire is parallel with the blades and the arrow on the inclinometer sticker points up.

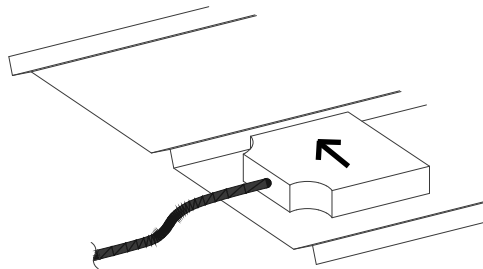

**NOTE:** If the unit has more than one outside air damper, mount the inclinometer on a horizontal-axis return air damper blade. (However, if the unit also has more than one return air damper, an AFMS cannot be installed.)

2. Attach the inclinometer to the damper blade with two #8 sheet metal screws.
3. Route the cord away from the damper so that it will not bind the damper.
4. Route the cord to the controller.

**NOTE:** Attach adequate strain relief (e.g. with wire ties) if needed to prevent the inclinometer from accidentally being pulled off of the damper blade during equipment maintenance.



# Mounting the Supply Airflow Pickup Tubes

There must be enough pressure flow pickup tubes must installed, for the size of the opening, to get an accurate average value for the air-stream. Multiple pickup tubes (at least 2) connected in a parallel pitot array are recommended.

The supply air pressure flow pickup tubes can be installed in one of three ways:

- *On the Supply Air Fan Bell (using SSS-1112/3/4) on page 6.*
- *On the Supply Air Fan Bell (using SSS-1115/6/7) on page 6.*
- *In the Supply Air Duct (using SSS-101x) on page 6.*

## On the Supply Air Fan Bell (using SSS-1112/3/4)

1. Position the pickup tubes' mounting foot on the edge of the fan bell so that the ends of the tubes are pointing toward the center of the fan inlet.

**NOTE:** All pickup points must be within the air-stream for accurate averaging of the differential pressure flow. If the pickup tubes are too long, use a shorter model.

2. Attach the tubes to the fan bell using two self-tapping screws inserted through the 3/16" mounting holes.
3. Repeat steps 1 to 2 to mount the remaining pickup tubes.

## On the Supply Air Fan Bell (using SSS-1115/6/7)

1. Position the pickup tubes so that the mounting feet span the fan inlet and all pickup points are within the air-stream.

**NOTE:** All pickup points must be within the air-stream for accurate averaging of the differential pressure flow. If the pickup tubes are too long, use a shorter model.

2. Attach the first mounting foot to the fan bell using two self-tapping screws inserted through the 3/16" mounting holes.
3. Attach the second mounting foot to the opposite edge of the fan bell (or the strut) using two self-tapping screws inserted through the 3/16" mounting cutouts.
4. Repeat steps 1 to 3 to mount the remaining pickup tubes.

## In the Supply Air Duct (using SSS-101x)

**NOTE:** The pressure flow pickup tubes should be mounted in filtered air in the location of laminar flow, which is **about 6 straight duct diameters** down the air duct.

1. Determine the duct's flow direction and install the pickup tubes based on the flow arrow imprint.

**NOTE:** The pickup tubes must be mounted with the arrow pointing in the direction of the airflow.

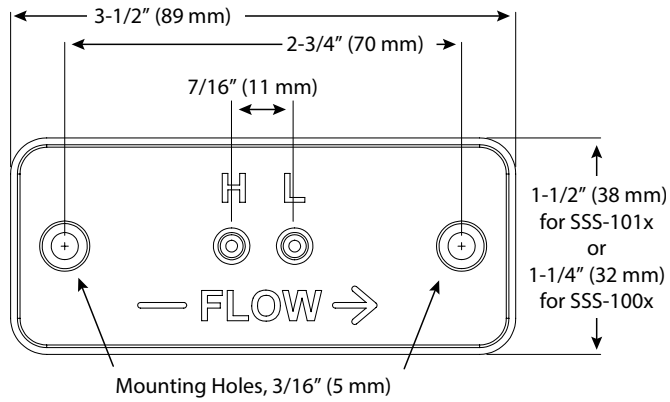

2. Cut a 7/8" hole in the duct to accept the pickup tubes.

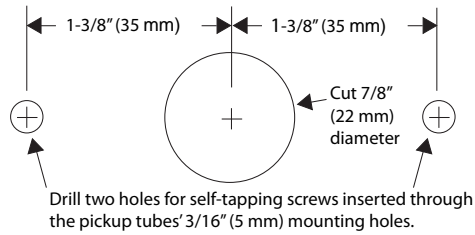

3. Attach the pickup tubes to the duct using two self-tapping screws inserted through the 3/16" mounting holes.

4. Repeat steps 1 to 3 to mount the remaining pickup tubes.

# Mounting Pickup Tubes for Pressure Assist

## Mounting for OAD Pressure Assist

Complete these additional steps only if installing a BAC-5901C-AFMS or BAC-5901CE-AFMS for an OAD pressure assist application. (See the *KMC AFMS Selection Guide* for details.)

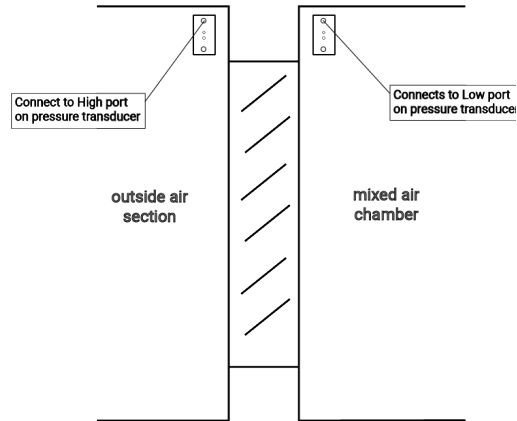

## Mounting the First Airflow Pickup Tube

1. Find a location for the first pickup tube outside of the outside air damper, in a location without turbulent flow from the incoming outside air-stream.

**NOTE:** For example, in a corner under the outside air intake hood. (See the drawing above.)

2. Determine the airflow direction in order to install the pickup tube so that the FLOW arrow imprint is *perpendicular* to the direction of the airflow (for *static* pressure measurement).

**NOTE:** In this case, the FLOW arrow imprint can point either up or down. Mark the SSS-10xx to assure others that this perpendicular orientation is indeed the intended orientation.

3. Cut a 7/8" (22 mm) hole in the duct to accept the pickup tube.
4. Attach the pickup tube to the sheet metal using two self-tapping screws inserted through the 3/16" (5 mm) mounting holes.

## Mounting the Second Airflow Pickup Tube

1. Find a location for the second pickup tube in the mixed air chamber, in a location without turbulent air flow.

**NOTE:** For example, in a corner of the mixed air chamber just inside of the outside air damper. (See the drawing above.)

2. Determine the airflow direction in order to install the pickup tube so that the FLOW arrow imprint is *perpendicular* to the direction of the airflow (for *static* pressure measurement).

**NOTE:** In this case, the FLOW arrow imprint can point either up or down. Mark the SSS-10xx to assure others that this perpendicular orientation is indeed the intended orientation.

3. Cut a 7/8" (22 mm) hole in the duct to accept the pickup tube.
4. Attach the pickup tube to the sheet metal using two self-tapping screws inserted through the 3/16" (5 mm) mounting holes.



## Mounting for RAD Pressure Assist

Complete these steps only if installing a BAC-5901C-AFMS or BAC-5901CE-AFMS for a RAD pressure assist application. (See the *KMC AFMS Selection Guide* for details.)

### Mounting the First Airflow Pickup Tube

1. Find a location for the first pickup tube near the return air damper, on the damper's upstream side.
2. Determine the airflow direction in order to install the pickup tube so that the FLOW arrow imprint is perpendicular to the direction of the airflow (for *static* pressure measurement).

**NOTE:** In this case, the FLOW arrow imprint can point either up or down (in a horizontal duct), or either left or right (in a vertical duct).

**NOTE:** It is recommended that a marking be applied to the SSS-10xx to assure others that this perpendicular orientation is indeed the intended orientation.

3. Cut a 7/8" (22 mm) hole in the duct to accept the pickup tube.
4. Attach the pickup tube to the sheet metal using two self-tapping screws inserted through the 3/16" (5 mm) mounting holes.

### Mounting the Second Airflow Pickup Tube

1. Find a location for the second pickup tube near the return air damper, on the damper's downstream (i.e. mixed air) side.
2. Determine the airflow direction in order to install the pickup tube so that the FLOW arrow imprint is perpendicular to the direction of the airflow (for *static* pressure measurement).

**NOTE:** In this case, the FLOW arrow imprint can point either up or down (in a horizontal duct), or either left or right (in a vertical duct).

**NOTE:** It is recommended that a marking be applied to the SSS-10xx to assure others that this perpendicular orientation is indeed the intended orientation.

3. Cut a 7/8" (22 mm) hole in the duct to accept the pickup tube.
4. Attach the pickup tube to the sheet metal using two self-tapping screws inserted through the 3/16" (5 mm) mounting holes.

# Mounting the Pressure Transducer(s)

**NOTE:** Complete these steps only if using a BAC-5901C(E)-AFMS controller.

**NOTE:** Avoid locations with severe vibrations or excessive moisture. The enclosure has a standard 1/2-inch conduit opening and may be installed with either a conduit coupler or a cable-gland-type fitting.

## CAUTION

**Do not use in explosive or hazardous environments, with combustible or flammable gasses, as a safety or emergency stop device, or in any other application where failure of the product could result in personal injury.**

1. Ensure there is enough space around the unit to make the pressure and electrical connections.
2. Use screws threaded through the case's mounting holes to fasten the assembly to a location near the array of pressure flow pickup tubes. Do not over-tighten.
3. If additional pressure flow pickup tubes were installed at the outside air damper or return air damper location for pressure assist measurements, repeat steps 1 and 2 for a second pressure transducer located near those pickup tubes.

# Mounting the OAT, RAT, and MAT Sensors

## STE-1411/12/13/14 Bendable Copper Sensor

Use a bendable copper sensor for easily-accessible mixed air sections and outside air hoods. If the mixed air section is not easily accessible, a flexible cable sensor may be used. If the unit does not have an easily-accessible outside air hood, a rigid steel probe may be used.

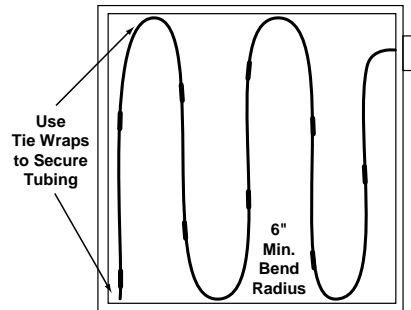
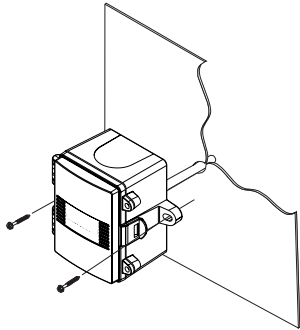

1. Cut a hole in the mixed air chamber of the unit large enough to feed the copper probe from the back of the enclosure.
2. Insert the sensor probe into the mixed air chamber, bend the probe tubing to cover the air path, and secure as needed.

**NOTE:** Maintain a **minimum bend radius of six inches** to prevent damage to the wires or sensors.

3. Fasten the enclosure to the unit by drilling holes in the side of the unit and threading screws through the mounting holes in the case.
4. For the cable leading to the AFMS controller, attach conduit to the 1/2" NPT threaded connection hole at the bottom of the enclosure as needed.
5. Open the cover by pulling slightly on the latch on the right side of the enclosure while pulling on the cover.

## STE-1415/6/7 Flexible Cable Sensor

A flexible cable sensor may be used if the mixed air section is not easily accessible.

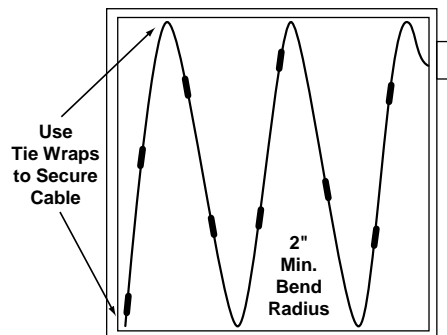
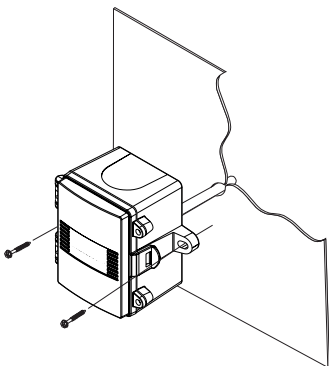

1. Cut a hole in the mixed air chamber of the unit large enough to feed the sensor cable from the back of the sensor enclosure.

2. Insert the sensor cable into the mixed air chamber, stringing the cable to cover the air path, and secure as needed.

**NOTE:** The flexible cable can be easily shaped to fit any duct size but observe a **minimum bend radius of two inches** to prevent damage to wires or sensors.

3. Fasten the enclosure to the unit by drilling holes in the side of the unit and threading screws through the mounting holes in the case.
4. For the cable leading to the AFMS controller, attach conduit to the 1/2" NPT threaded connection hole at the bottom of the enclosure as needed.
5. Open the cover by pulling slightly on the latch on the right side of the enclosure while pulling on the cover.

## STE-1404/05 Rigid Steel Probe

Use a rigid probe for the return air duct. A rigid probe may also be used for the outside air duct, but only if the unit does not have an easily-accessible outside air hood.

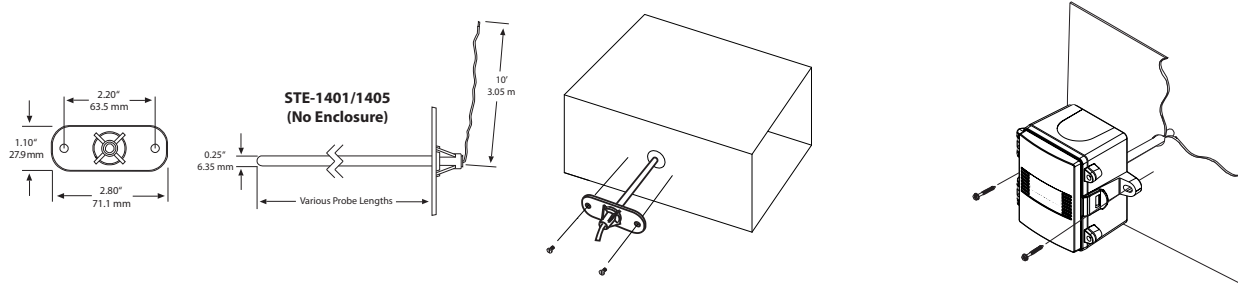

1. Locate the sensor in a straight section of duct, away from heating, cooling, or humidifier sources.
2. Cut a 1/4-inch hole for the probe in the side of the duct as well as smaller holes for screws at the appropriate locations.
3. Insert the probe and fasten the assembly to the duct using screws threaded through the mounting holes in the housing.
4. Open the sensor cover (STE-1404 only) by pulling slightly on the latch on the right side of the enclosure while pulling on the cover.
5. For the cable leading to the AFMS controller, attach conduit to the 1/2" NPT threaded connection hole at the bottom of the enclosure as needed.

# Mounting a Proportional Actuator

Complete these steps only if there is not a proportional actuator already mounted on the correct damper for the application needed:

- For standard or OAD applications, mount the proportional actuator on the outside air damper (or, alternatively, on the return air damper, if it moves together with the outside air damper).
- For RAD pressure assist applications, mount the proportional actuator on the return air damper (or, alternatively, on an outside air damper that moves together with the return air damper).

For instructions on how to mount your particular model of MEP-series proportional actuator:

1. Select the appropriate link from the list, or search for it on the KMC Controls website:

- [MEP-4552](#)
- [MEP-4952](#)
- [MEP-7552](#)

2. Access the installation guide found on that model's product page.

3. Follow the instructions for mounting, on the appropriate damper for the application needed:

- For standard or OAD pressure assist applications, mount the proportional actuator on the outside air damper (or, alternatively, on the return air damper, if it moves together with the outside air damper).
- For RAD pressure assist applications, mount the proportional actuator on the return air damper (or, alternatively, on an outside air damper that moves together with the return air damper).

# Connecting System Components to the Controller

## Connecting the Airflow Pickup Tubes

### For a BAC-5901C(E)-AFMS

Use appropriately sized polyethylene tubing for the pressure connections. The length of the tubing should not be longer than necessary. Arrange the tubing to minimize stress on the connections and prevent kinking.

### Connecting the Supply Airflow Pickup Tubes to the Pressure Transducer

1. With tubing, connect the Port Hs of all the pickup tubes in parallel in a loop, then connect to the High input on the supply air pressure transducer.
2. With tubing, connect the Port Ls of all the pickup tubes in parallel in a loop, then connect to the Low input on the supply air pressure transducer.

### Connecting the Airflow Pickup Tubes for OAD Pressure Assist Applications

Complete these steps if two additional SSS-1000 series pickup tubes were installed at the location of the outside air damper for pressure assist.

1. For the pickup tube mounted *outside* of the outside air damper, connect one of its ports, with tubing, to the **High** input on the transducer used for pressure assist.

**NOTE:** It does not matter, in this application, which pickup tube port (**H** or **L**) is connected to the transducer's **High** input.

2. For the pickup tube mounted *inside* of the outside air damper, connect one of its ports, with tubing, to the **Low** input on the transducer used for pressure assist.

**NOTE:** It does not matter, in this application, which pickup tube port (**H** or **L**) is connected to the transducer's **Low** input.

**NOTE:** The other ports of the two pickup tubes are left unconnected and open to air.

### Connecting the Airflow Pickup Tubes for RAD Pressure Assist Applications

Complete these steps if two additional SSS-1000 series pickup tubes were installed at the location of the return air damper for pressure assist.

1. For the pickup tube mounted on the *upstream* side of the return air damper, connect one of its ports, with tubing, to the **High** input on the transducer used for pressure assist.

**NOTE:** It does not matter, in this application, which pickup tube port (**H** or **L**) is connected to the transducer's **High** input.

2. For the pickup tube mounted on the *downstream* (i.e. mixed air) side of the return air damper, connect one of its ports, with tubing, to the **Low** input on the transducer used for pressure assist.

**NOTE:** It does not matter, in this application, which pickup tube port (**H** or **L**) is connected to the transducer's **Low** input.



**NOTE:** The other ports of the two pickup tubes are left unconnected and open to air.

## Connecting the Pressure Transducer(s) to the Controller

1. Connect the signal wire from OUT on the supply air pressure transducer to UI9 on the controller.
2. If installing a second transducer for (OAD or RAD) pressure assist applications, connect the signal wire from OUT on the second transducer to UI10 on the controller.

## For a BAC-9311C(E)-AFMS

**NOTE:** Use 1/4 inch (6.35 mm) FR tubing. Tubing should not be longer than 20 feet (6 meters).

1. Remove the black shipping plugs from the PRESSURE SENSOR ports.
2. With tubing, connect the Port Hs of all the pickup tubes in parallel in a loop, then connect to the **HIGH** 7
3. With tubing, connect the Port Ls of all the pickup tubes in parallel in a loop, then connect to the **LOW** 8



## Connecting the Inclinator

1. Connect the inclinometer's yellow signal wire to UI7 on the controller.
2. Connect the inclinometer's green signal wire to UI8 on the controller.
3. Connect the inclinometer's blue ground wire to GND (between UI7 and UI8) on the controller.
4. Connect the inclinometer's red power wire to either U08 (for a BAC-5901C[E]-AFMS) or U10 (for a BAC-9311C[E]-AFMS).

## Connecting the Outside Air Temperature Sensor

**NOTE:** Use 18 to 24 AWG shielded wiring for all connections. Do not locate the device wires in the same conduit with wiring used to supply inductive loads such as motors.

1. Bring the cable that will go to the AFMS controller through the bottom hole.
2. Make connections to the two wire leads with either butt-splices or solder. (Using wire nuts is **not** recommended.)

**NOTE:** The two-wire sensor is not polarity sensitive.

3. Plug the conduit with sealant to prevent air infiltration.
4. Swing the door closed until securely latched.
5. If desired for added security, install the two (provided) screws in the door's integrated screw tabs.
6. Connect the sensor's signal wire to UI4 on the controller.
7. Connect the sensor's ground wire to GND (next to UI4) on the controller.

## Connecting the Return Air Temperature Sensor

**NOTE:** Use 18 to 24 AWG shielded wiring for all connections. Do not locate the device wires in the same conduit with wiring used to supply inductive loads such as motors.

1. Feed the wire that will go to the AFMS controller through the bottom hole (if applicable).
2. Make connections to the two wire leads with either butt-splices or solder. (Using wire nuts is **not** recommended.)

**NOTE:** The two-wire sensor is not polarity sensitive.

3. Plug the conduit with sealant to prevent air infiltration.
4. Swing the door (if applicable) closed until securely latched.
5. If desired for added security (and if applicable), install the two (provided) screws in the door's integrated screw tabs.
6. Connect the sensor's signal wire to UI5 on the controller.
7. Connect the sensor's ground wire to GND (next to UI5) on the controller.

## Connecting the Mixed Air Temperature Sensor

**NOTE:** Use 18 to 24 AWG shielded wiring for all connections. Do not locate the device wires in the same conduit with wiring used to supply inductive loads such as motors.

1. Feed the wire that will go to the AFMS controller through the bottom hole.
2. Make connections to the two wire leads with either butt-splices or solder. (Using wire nuts is **not** recommended.)

**NOTE:** The two-wire sensor is not polarity sensitive.

3. Plug the conduit with sealant to prevent air infiltration.
4. Swing the door closed until securely latched.

**NOTE:** If desired for added security, install the two (provided) screws in the door's integrated screw tabs.

5. Connect the sensor's signal wire to UI6 on the controller.
6. Connect the sensor's ground wire to GND (next to UI6) on the controller.

# Connecting the Proportional Actuator

## Using an Existing Proportional Actuator

**NOTE:** Follow the procedure in this section when installing the AFMS into a unit that already has a proportional actuator, which is controlled by another controller, mounted to the outdoor or return air damper.

### CAUTION

**Power off the actuator and the other controller before taking the following steps!**

1. Disconnect from the existing actuator the signal wire that comes from the output of the other controller.
2. Disconnect from the existing actuator the ground wire that comes from the other controller.
3. Connect the signal wire (coming from the other controller) to UI3 on the AFMS controller.
4. Connect the ground wire (coming from the other controller) to the GND terminal (next to UI3) on the AFMS controller.
5. Run a new signal wire – from U07 on a BAC-5901-AFMS, or from U09 on a BAC-9311-AFMS – to the signal terminal on the actuator.
6. Connect the signal common wire of that new (twisted pair) wire to the GND terminal (next to U07/U09) on the AFMS controller.

## Using a New Proportional Actuator

For instructions on how to wire your particular model of actuator to the controller:

1. Click on the appropriate model from the list, or search for it on the KMC Controls website:

- [MEP-4552](#)
- [MEP-4952](#)
- [MEP-7552](#)

2. Access the installation guide found on that model's product page.
3. Follow all instructions on wiring to the controller that apply to your model of actuator.

**NOTE:** For information on which controller inputs and outputs to wire to, see [Wiring Diagrams on page 24](#) and [Input/Output Objects/Connections on page 30](#).

**NOTE:** For information on which controller inputs and outputs to wire to, see [Wiring Diagrams on page 24](#) and [Input/Output Objects/Connections on page 30](#).

# Connecting Networks

## Connecting an Ethernet Network

For “E” models only, connect an **Ethernet patch cable** to the **10/100 ETHERNET port 9**.

### ⚠ CAUTION

**Do NOT plug a cable meant for Ethernet communications into the Room Sensor port! The Room Sensor port powers a NetSensor. The supplied voltage may damage an Ethernet switch or router.**

**NOTE:** The Ethernet patch cable should be T568B Category 5 or better and a maximum of 328 feet (100 meters) between devices.

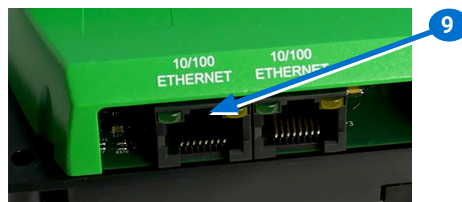

**NOTE:** Ethernet-enabled “E” models with the latest firmware can be configured with a web browser from pages served from within the controller. The controllers have the following default network address values:

- IP address—192.168.1.251
- Subnet mask—255.255.255.0
- Gateway—192.168.1.1

## Connecting an MS/TP Network

1. For a BAC-5901C-AFMS or BAC-9311C-AFMS, connect the BACnet network to the **gray BACnet MS/TP terminal block 10**.



**NOTE:** Use 18 gauge AWG shielded twisted pair cable with maximum capacitance of 51 picofarads per foot (0.3 meters) for all network wiring (Belden cable #82760 or equivalent).

- A. Connect the **-A** terminals in parallel with all other **-A** terminals on the network.
  - B. Connect the **+B** terminals in parallel with all other **+B** terminals on the network.
  - C. Connect the **shields** of the cable together at each device using a wire nut or the **S** terminal in KMC BACnet controllers.
2. Connect the cable shield to a good earth ground at **one end only**.

**NOTE:** For principles and good practices when connecting an MS/TP network, see [Planning BACnet Networks \(Application Note AN0404A\)](#).

3. If the controller is at either end of a BACnet MS/TP network (only one wire under the terminals), turn the **EOL switch** to **ON**.

**NOTE:** The EOL switch is shipped from the factory in the OFF position.

# Connecting Power

## Connecting Power to the Controller

To connect a 24 VAC, Class-2 transformer to the **black power terminal block** of the controller:

1. Connect the neutral side of the transformer to the controller's **common terminal** **⊥** **11**.
2. Connect the AC phase side of the transformer to the controller's **phase terminal** **~** **12**.



**NOTE:** Connect only one controller to each 24 VAC, Class-2 transformer with 12–24 AWG copper wire.

**NOTE:** Use either shielded connecting cables or enclose all cables in conduit to maintain RF emissions specifications.

**NOTE:** To use **DC** power supply instead of AC, see the “Power (Controller) Connections” section of the **KMC Conquest Controller Application Guide**.

## Connecting Power to the Inclinometer

1. Connect the inclinometer's red power wire to U08 for a BAC-5901-AFMS, or U010 for a BAC-9311-AFMS.
2. Connect the inclinometer's blue ground wire to GND/SC on the controller.

## Connecting Power to the Pressure Transducer(s)

**NOTE:** Complete these steps only if using a BAC-5901C(E)-AFMS controller.

**NOTE:** Use at least 22 AWG, shielded, twisted-pair wiring for all connections. Do not locate device wires in the same conduit with wires supplying inductive loads.

### **⚠ CAUTION**

**When grounding the secondary of an AC transformer or when wiring multiple devices, ensure that the circuit ground point is the same on all devices and the controller.**

1. Connect the controller's **phase terminal** **~** to the transducer's **PWR** terminal.
2. Connect the controller's **common terminal** **⊥** to the **COM** terminal on the transducer.
3. If there is a second transducer for pressure assist applications, repeat steps 1 and 2 for that transducer.



# Connecting Power to the Proportional Actuator

For instructions on how to wire to power and complete setup of your particular model of actuator:

1. Select the appropriate model from the list, or search for it on the KMC Controls website:
  - [MEP-4552](#)
  - [MEP-4952](#)
  - [MEP-7552](#)
2. Access the installation guide found on that model's product page.
3. Follow all instructions on wiring to power and remaining setup that apply to your model of actuator.

# Controller Power and Communication Status

The **status LEDs** on a BAC-5901-AFMS and BAC-9311-AFMS indicate power connection and network communication. The descriptions below describe their activity during **normal operation** (at least 5 to 20 seconds **after** power-up/initialization or restart).

**NOTE:** If both the green READY LED and the amber COMM LED remain OFF, check the power and cable connections to the controller.

## Green READY LED

After controller power-up or restart is complete, the READY LED **13** flashes steadily about once per second, indicating normal operation.



## Amber (BACnet MS/TP) COMM LED

- During normal operation, the COMM LED **14** flickers as the controller receives and passes the token over the BACnet MS/TP network.
- When the network is **not** connected or communicating properly, the COMM LED flashes more slowly (about once a second).

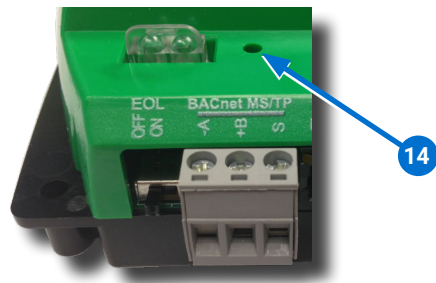

## Green ETHERNET LED

**NOTE:** The Ethernet status LEDs **15** indicate network connection and communication speed.

- The green Ethernet LED stays ON when the controller is communicating with the network.
- The green Ethernet LED is OFF when the (powered) controller is **not** communicating with the network.

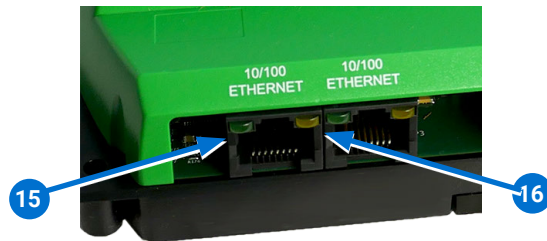

## Amber ETHERNET LED

- The amber Ethernet LED **16** flashes when the controller is communicating with a 100BaseT Ethernet network.
- The amber Ethernet LED remains OFF when the (powered) controller is communicating with the network at only 10 Mbps (instead of 100 Mbps).

## Controller MS/TP Network Isolation Bulbs

The two **network isolation bulbs** **17** serve three functions:

- Removing the (**HPO-0055**) bulb assembly opens the MS/TP circuit and isolates the controller from the network.
- If one or both bulbs are ON, the network is improperly phased. This means the ground potential of the controller is not the same as other controllers on the network. If this happens, fix the wiring.
- If the voltage or current on the network exceeds safe levels, the bulbs blow, opening the circuit. If this happens, fix the problem and replace the bulb assembly.

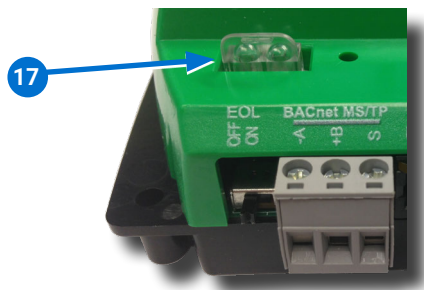

# Wiring Diagrams



## KMC Conquest Airflow Measurement System Model: BAC-5901C(E)

### AFMS LAYOUT

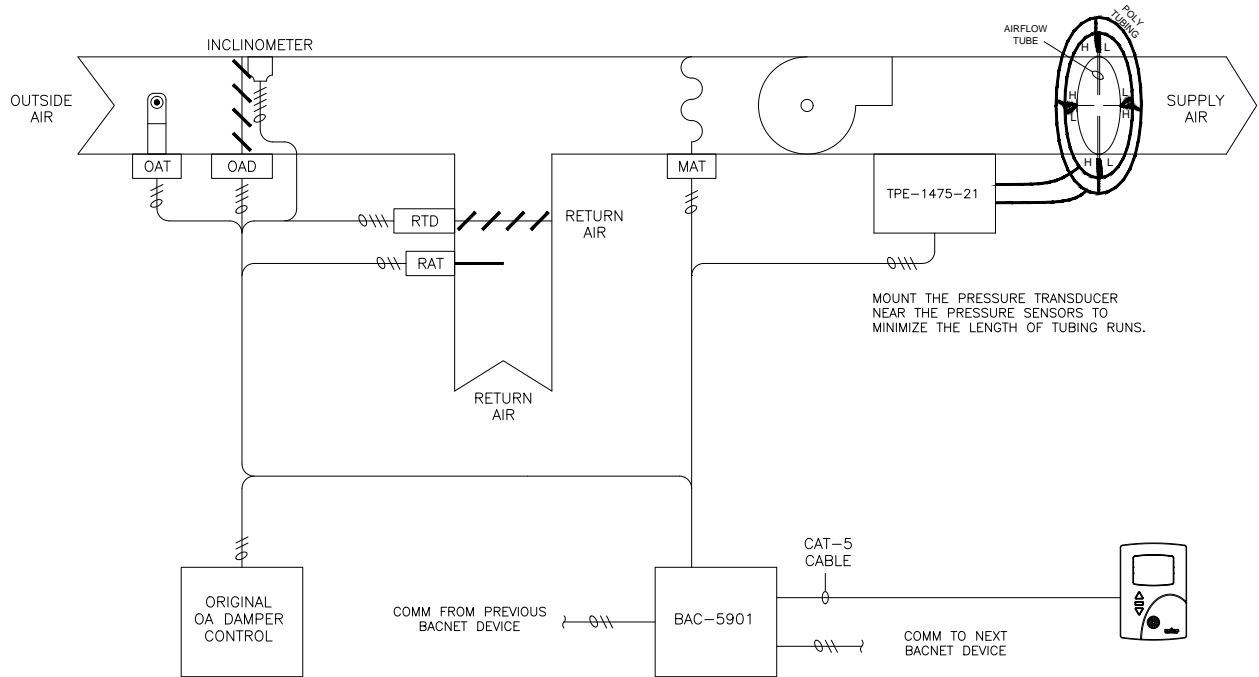

### INCLINOMETER MOUNTING

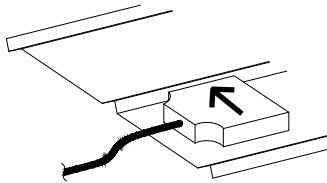

MOUNT THE INCLINOMETER TO A HORIZONTAL DAMPER BLADE (PREFERABLY OUTSIDE AIR) WITH THE CORD RUNNING PARALLEL TO THE DAMPER BLADE. ATTACH WITH TWO #8 SHEET METAL SCREWS AND SECURE THE CORD IN SUCH A WAY AS TO AVOID DAMAGE TO THE CABLE DURING NORMAL USE AS WELL AS TO NOT IMPEDE DAMPER OPERATION.

### SUPPLY AIR FLOW MEASUREMENT

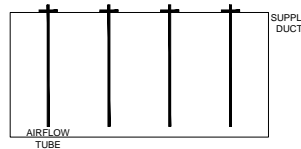
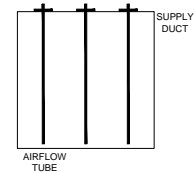
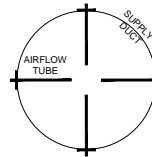

INSTALL ENOUGH DIFFERENTIAL PRESSURE FLOW SENSORS TO GET AN ACCURATE AVERAGE FLOW READING FOR THE DUCT (AT LEAST 2), IDEALLY IN LAMINAR FLOW WHICH IS ABOUT 6 STRAIGHT DUCT WIDTHS DOWN THE SUPPLY DUCT. INSTALL SO ALL HIGH PRESSURE PORTS ARE FACING UPSTREAM AND LOW PORTS ARE FACING DOWNSTREAM. CONNECT ALL HIGH PORTS IN PARALLEL IN A LOOP AS SHOWN ON THE WIRING DIAGRAM AND CONNECT TO THE HIGH PORT OF THE CONTROLLER. DO THE SAME FOR THE LOW PORTS.

### NOTES:

1. Controller settings must be initially set using an STE-9XX1.
2. See the AFMS Selection, Installation and Application Guides for additional installation details.
3. See [www.kmccontrols.com](http://www.kmccontrols.com) for accessories and additional details.

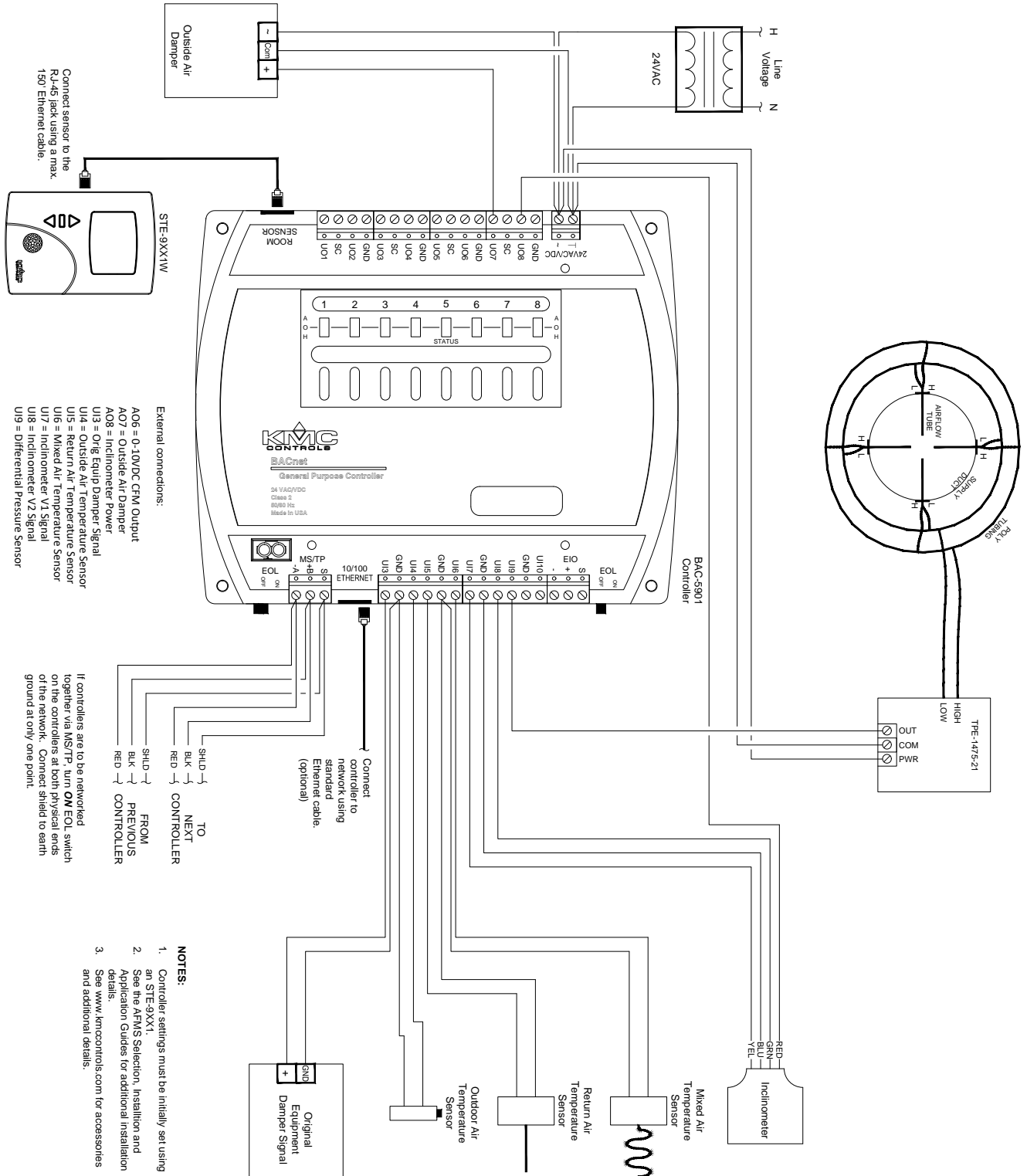

AFMS LAYOUT

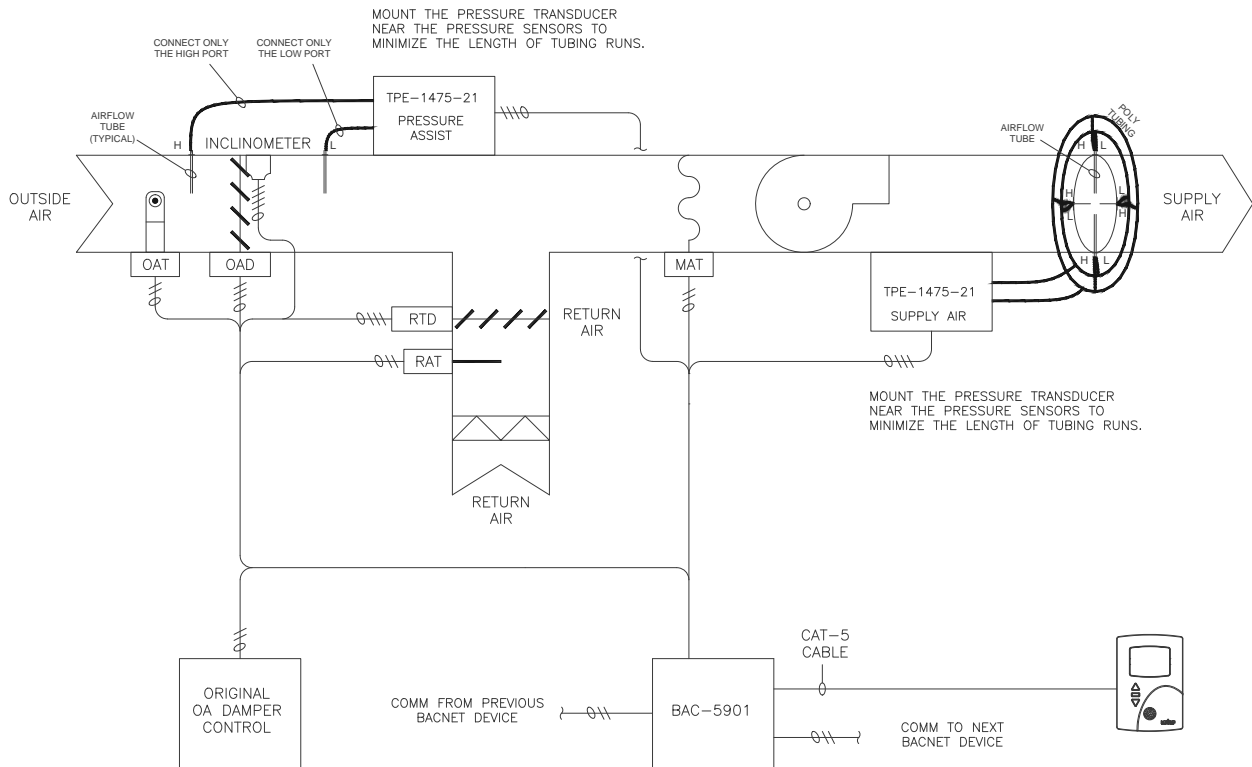

INCLINOMETER MOUNTING

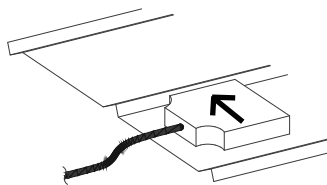

MOUNT THE INCLINOMETER TO A HORIZONTAL DAMPER BLADE (PREFERABLY OUTSIDE AIR) WITH THE CORD RUNNING PARALLEL TO THE DAMPER BLADE. ATTACH WITH TWO #8 SHEET METAL SCREWS AND SECURE THE CORD IN SUCH A WAY AS TO AVOID DAMAGE TO THE CABLE DURING NORMAL USE AS WELL AS TO NOT IMPEDE DAMPER OPERATION.

AIR FLOW MEASUREMENT

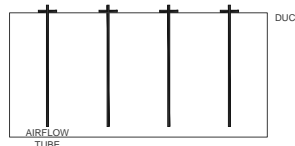
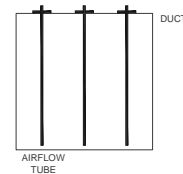
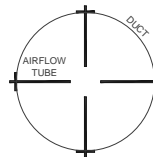

INSTALL ENOUGH DIFFERENTIAL PRESSURE FLOW SENSORS TO GET AN ACCURATE AVERAGE FLOW READING FOR THE DUCT (AT LEAST 2), IDEALLY IN LAMINAR FLOW WHICH IS ABOUT 6 STRAIGHT DUCT WIDTHS DOWN THE SUPPLY DUCT. INSTALL SO ALL HIGH PRESSURE PORTS ARE FACING UPSTREAM AND LOW PORTS ARE FACING DOWNSTREAM. CONNECT ALL HIGH PORTS IN PARALLEL IN A LOOP AS SHOWN ON THE WIRING DIAGRAM AND CONNECT TO THE HIGH PORT OF THE CONTROLLER. DO THE SAME FOR THE LOW PORTS.

**NOTES:**

1. Controller settings must be initially set using an STE-9XX1.
2. See the AFMS Selection, Installation and Application Guides for additional installation details.
3. See [www.kmccontrols.com](http://www.kmccontrols.com) for accessories and additional details.



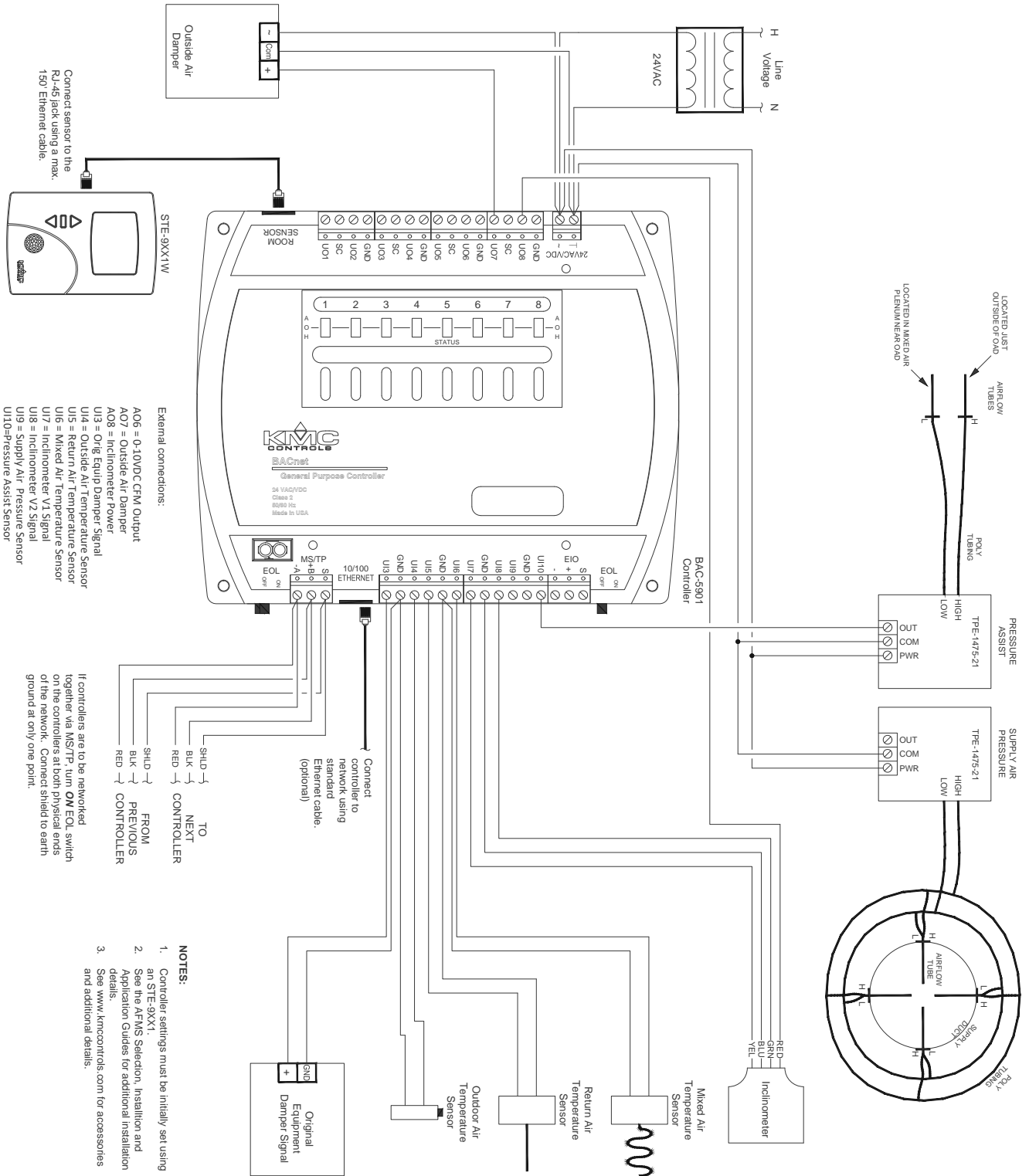

AFMS LAYOUT

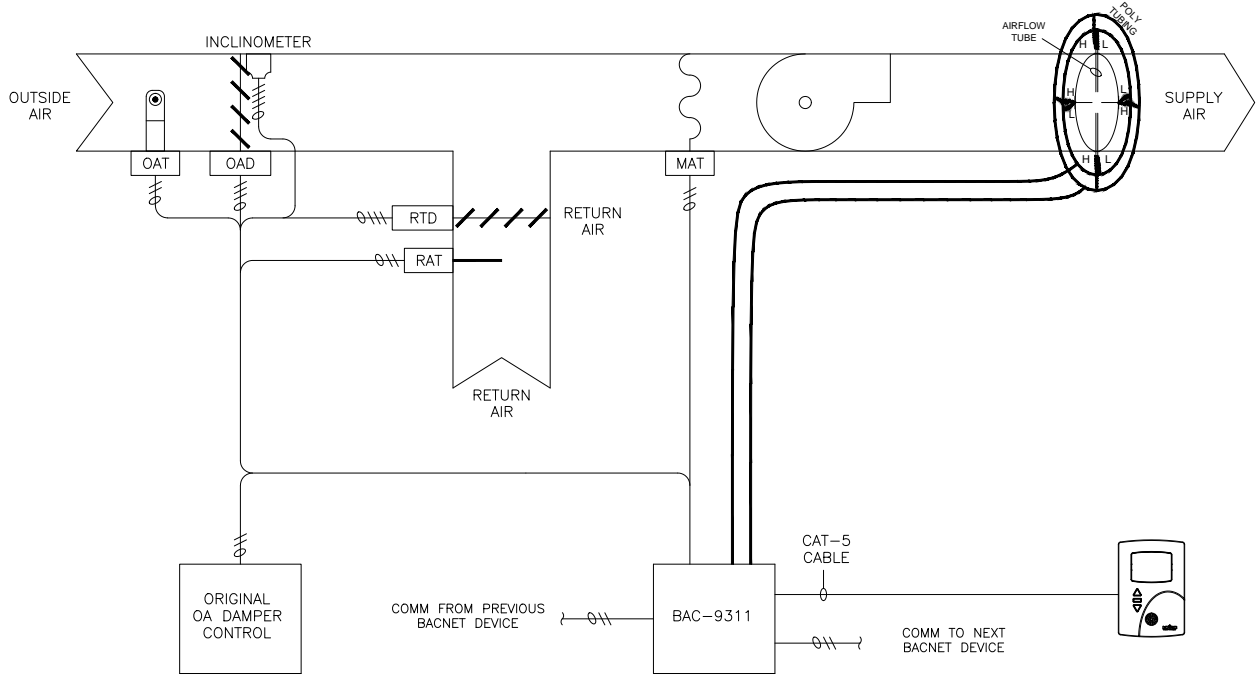

INCLINOMETER MOUNTING

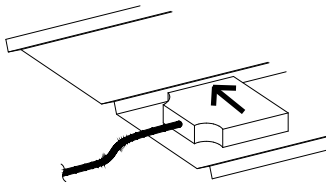

MOUNT THE INCLINOMETER TO A HORIZONTAL DAMPER BLADE (PREFERABLY OUTSIDE AIR) WITH THE CORD RUNNING PARALLEL TO THE DAMPER BLADE. ATTACH WITH TWO #8 SHEET METAL SCREWS AND SECURE THE CORD IN SUCH A WAY AS TO AVOID DAMAGE TO THE CABLE DURING NORMAL USE AS WELL AS TO NOT IMPEDE DAMPER OPERATION.

SUPPLY AIR FLOW MEASUREMENT

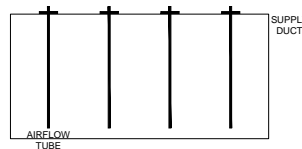
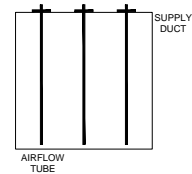
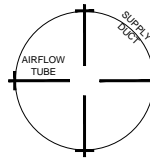

INSTALL ENOUGH DIFFERENTIAL PRESSURE FLOW SENSORS TO GET AN ACCURATE AVERAGE FLOW READING FOR THE DUCT (AT LEAST 2), IDEALLY IN LAMINAR FLOW WHICH IS ABOUT 6 STRAIGHT DUCT WIDTHS DOWN THE SUPPLY DUCT. INSTALL SO ALL HIGH PRESSURE PORTS ARE FACING UPSTREAM AND LOW PORTS ARE FACING DOWNSTREAM. CONNECT ALL HIGH PORTS IN PARALLEL IN A LOOP AS SHOWN ON THE WIRING DIAGRAM AND CONNECT TO THE HIGH PORT OF THE CONTROLLER. DO THE SAME FOR THE LOW PORTS.

**NOTES:**

1. Controller settings must be initially set using an STE-9XX1.
2. See the AFMS Selection, Installation and Application Guides for additional installation details.
3. See [www.kmcccontrols.com](http://www.kmcccontrols.com) for accessories and additional details.

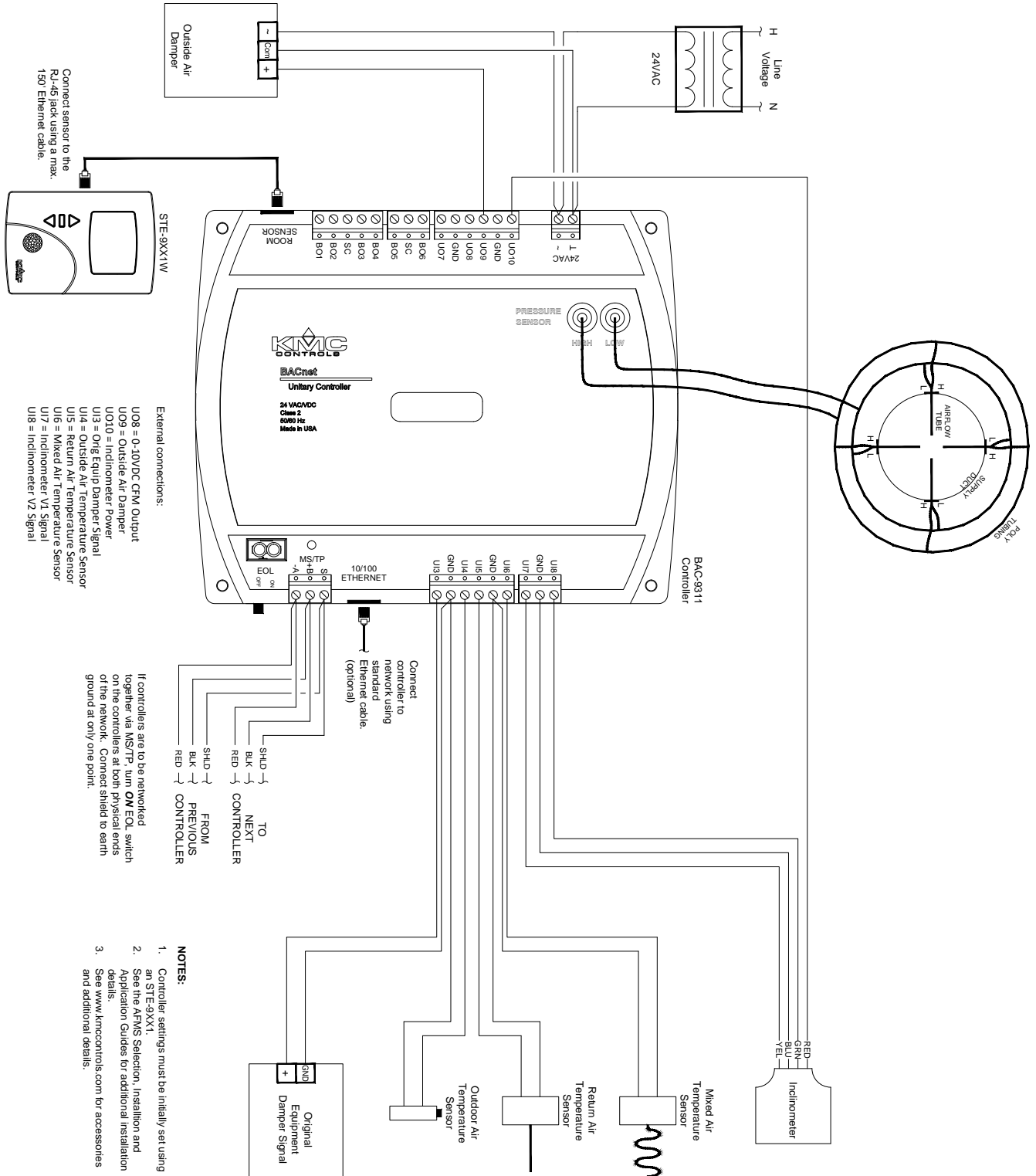

# Input/Output Objects/Connections

BAC-5901C(E)-AFMS	
Inputs	
A1/1	Space Sensor ( <i>on Room Sensor port</i> )
A2/2	Space Setpoint Offset ( <i>on port</i> )
A3/UI3	Incoming Damper Signal
A4/UI4	Outdoor Air Temp
A5/UI5	Return Air Temp
A6/UI6	Mixed Air Temp
A7/UI7	Inclinometer V1
A8/UI8	Inclinometer V2
A9/UI9	Supply Air Pressure Transducer
A10/UI10	Additional Transducer (if pressure assist is needed)
Outputs	
A06/U06	0-10 VDC CFM Output
A07/U07	Outdoor Air Damper
A08/U08	Inclinometer Power
B01	Binary Output #1
B02	Binary Output #2
B03	Binary Output #3
B04	Binary Output #4
B05	Binary Output #5

BAC-9311C(E)-AFMS	
Inputs	
A1/1	Space Sensor ( <i>on Room Sensor port</i> )
A2/2	Space Setpoint Offset ( <i>on port</i> )
A3/UI3	Incoming Damper Signal
A4/UI4	Outdoor Air Temp
A5/UI5	Return Air Temp
A6/UI6	Mixed Air Temp
A7/UI7	Inclinometer V1
A8/UI8	Inclinometer V2
A/9	Differential Pressure Sensor ( <i>integrated port</i> )
Outputs	
A07/U07	Analog Output #7
A08/U08	0-10 VDC CFM Output
A09/U09	Outdoor Air Damper
A010/U010	Inclinometer Power
B01	Binary Output #1
B02	Binary Output #2
B03	Binary Output #3
B04	Binary Output #4
B05	Binary Output #5
B06	Binary Output #6

## Configuring and Operating

For each tool used to configure and operate the AFMS, see the documentation found on the tool's product page.

PROCESSES	CONFIGURATION TOOLS						
	BAC-5051(A)E router	Ethernet controller <sup>1</sup> served web pages	Conquest™ NetSensor	KMC Connect™ or TotalControl™	KMC Converge™ for Niagara Workbench	KMC Commander® <sup>2</sup>	KMC Connect Lite™ (NFC) app <sup>3</sup>
Selecting the application		✓	✓	✓			
Configuring communication		✓	✓	✓	✓		✓
Setting AFMS parameters	✓	✓	✓	✓	✓	✓	
Calibrating sensors	✓	✓	✓	✓	✓	✓	
Starting Learning Mode	✓	✓	✓	✓	✓	✓	
Controlling airflow	✓	✓	✓	✓	✓	✓	
Monitoring operation & faults	✓	✓	✓	✓	✓	✓	

<sup>1</sup> Ethernet (E) models can be configured with a web browser from pages served within the controller.

<sup>2</sup> KMC Commander's AFMS module currently supports the standard AFMS application only.

<sup>3</sup> Near Field Communication via enabled smart phone or tablet running the KMC Connect Lite app.

# Important Notices

The material in this document is for information purposes only. The contents and the product it describes are subject to change without notice.

KMC Controls, Inc. makes no representations or warranties with respect to this document. In no event shall KMC Controls, Inc. be liable for any damages, direct, or incidental, arising out of or related to the use of this document.

The KMC logo is a registered trademark of KMC Controls, Inc. All rights reserved.

The KMC Connect Lite™ app for NFC configuration is protected under United States Patent Number 10,006,654. Pat. <https://www.kmccontrols.com/patents/>

TEL: 574.831.5250

FAX: 574.831.5252

EMAIL: [info@kmccontrols.com](mailto:info@kmccontrols.com)

