

INTRODUCTION

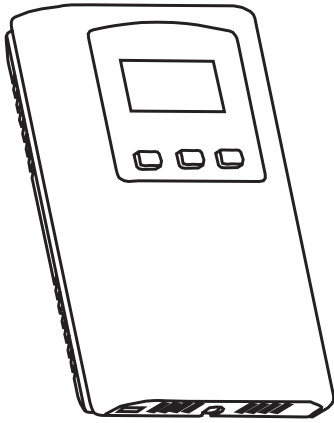

The room CO₂ transmitter device uses a highly accurate and reliable non-dispersive infrared (NDIR) sensor in an attractive, low profile enclosure for room applications to monitor CO₂ levels. The sensor uses dual channel optics and LTA (long term adjustment) signal processing technology to deliver industry leading long-term accuracy and reliability. These technology features ensure optimum measurement stability for both periodic and constant occupancy applications, so the device is equally suitable for the classroom or the hospital room.

Standard features include a field selectable output signal of either 4-20 mA, 0-5 Vdc or 0-10 Vdc for the highest versatility, programmable CO₂ measurement span, a backlit alpha-numeric LCD and easy menu operation for configuration.

Optional features include a resistive temperature sensor output (with LCD display of temperature in either °C or °F), a control relay with programmable setpoint, hysteresis and time delay, an up/down setpoint control with various resistive output ranges and a dry-contact override switch.

BEFORE INSTALLATION

Read these instructions carefully before installing and commissioning the device. Failure to follow these instructions may result in product damage. Do not use in an explosive or hazardous environment, with combustible or flammable gases, as a safety or emergency stop device or in any other application where failure of the product could result in personal injury. Take electrostatic discharge precautions during installation. De-energize the power supply prior to installation, this device is intended for indoor air conditioned spaces, contact factory or other applications. **Do not exceed device ratings. This product is not intended for life-safety applications.**

NOTE: This CO₂ sensor incorporates a Self Calibration feature to correct CO₂ sensor drift. This feature is recommended for applications where the CO₂ will be exposed to fresh air (400 ppm) at least one hour per day. If the monitored space is occupied 24 hours or consistently maintains higher or lower levels of CO₂, it is recommended that this feature be turned off, but yearly calibration will be required. If the self calibration is disabled at installation time without allowing for 7 day auto calibration cycle, then a manual calibration should be performed to ensure accuracy of the device.

MOUNTING

The transmitter installs directly on a standard electrical box and should be mounted five feet from the floor of the area to be controlled. Do not mount the sensor near doors, opening windows, supply air diffusers or other known disturbances. Avoid areas where the detector is exposed to vibrations or rapid temperature changes. Prevent measurement errors by sealing the wall or conduit openings to prevent air migration from the wall cavity.

The cover is hooked to the base at the top edge and must be removed from the bottom edge first. Use a small Phillips screwdriver to loosen the security screw as shown in Figure 1. Complete removal of the screw is not required. Use the screwdriver to carefully pry each bottom corner if necessary. Tip the cover away from the base and sit it aside as shown in Figure 2.

Figure 1

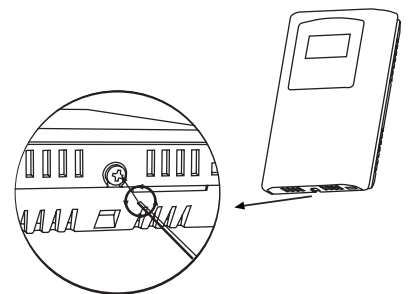

Figure 2

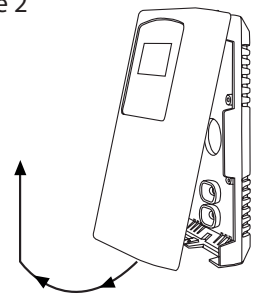

Figure 3

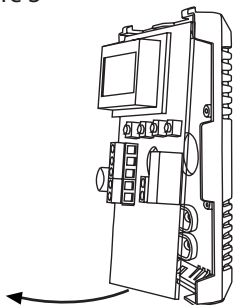
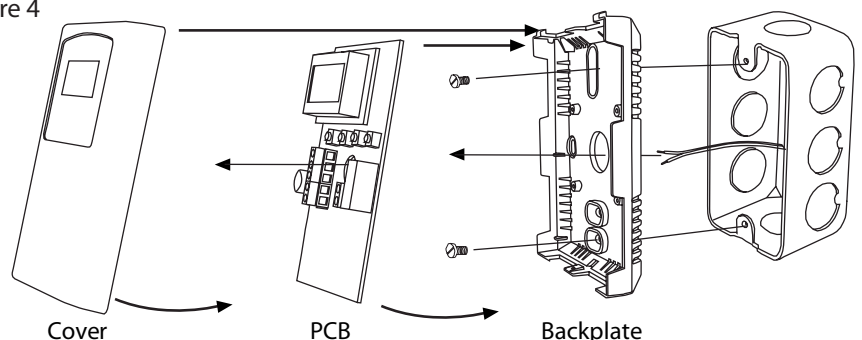

Figure 4



The PCB must be removed from the base to access the mounting holes. Follow anti-static procedures when handling the PCB and be careful not to touch the sensors.

The PCB is removed by pressing the enclosure base to unsnap the latch near the bottom edge, then the PCB can be lifted out of the base as shown in Figure 3.

Sit the PCB aside until the base is mounted on the wall. For added protection, place the PCB in the supplied anti-static bag.

Mount the base by screwing to an electrical box or directly to the wall as shown in Figure 4.

After the base is screwed to an electrical box or directly to the wall using the appropriate holes, remove the PCB from the anti-static bag, feed connection wires through the center hole and place the top of the PCB into the PCB holders on the backplate and snap the bottom of the PCB into place as shown in Figure 4.

Making wiring connections as per the Wiring Illustrations on page 2 and install the decorative cover by placing the top of the cover into the cover holder on the top of the backplate and snapping the bottom into place as shown in Figure 4. Tighten the security screw with a Phillips screwdriver.

WIRING

Deactivate the power supply until all connections are made to the device to prevent electrical shock or equipment damage. Use 16-22 AWG shielded wire for all connections (only ground the shield at the controller end) and do not locate the device wires in the same conduit with wiring used to supply inductive loads such as motors. Pull at least six inches of wire into the enclosure and complete the wiring connection according to the wiring diagram. Figure 6.

This is a 3-wire sourcing device. Connect the plus DC or the AC voltage hot side to the PWR terminal and the common is connected to the COM terminal. The device is reverse voltage protected and will not operate if

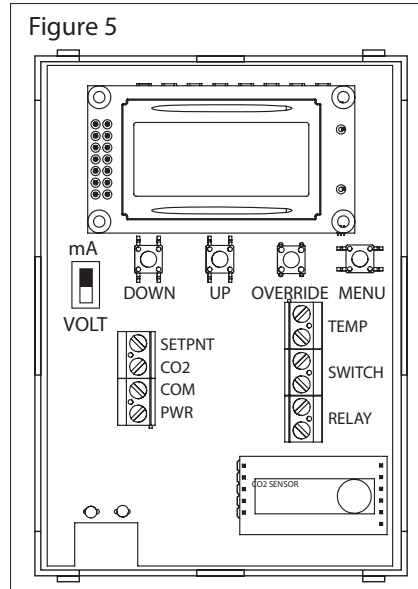
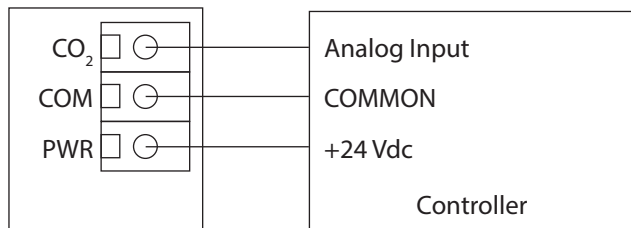

Figure 6 Wiring for CO₂ output signal and 24 Vdc power from controller



Wiring for all output and external 24 Vac power transformer or external 24 Vac power supply

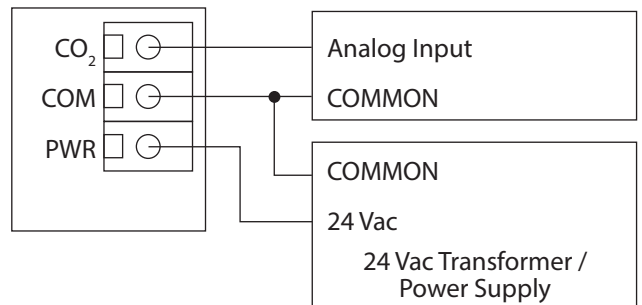

Figure 7

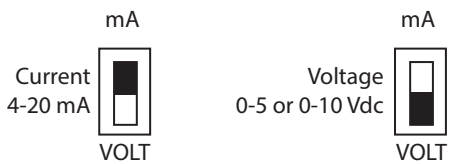

Figure 8

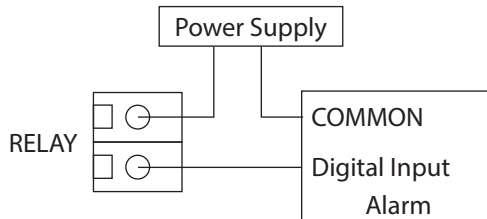
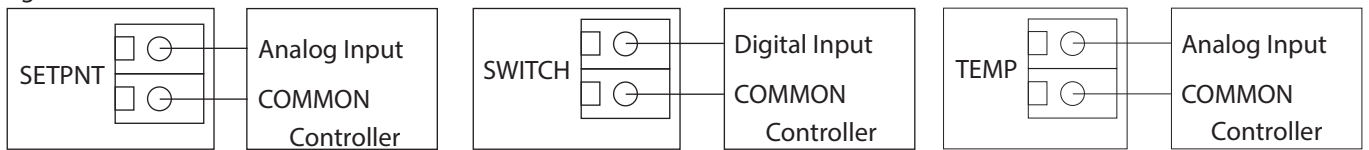

Figure 9



connected backwards. It has a half-wave power supply so the supply common is the same as the signal common. Several devices may be connected to one power supply and the output signals all share the same common. Use caution when grounding the secondary of a transformer or when wiring multiple devices to ensure the ground point is the same on all devices and the controller.

The CO₂ analog output is available on the CO₂ terminal. This signal is switch selectable for either 4-20 mA or voltage output (0-5 / 0-10 Vdc) see Figure 7 and connects to the controller analog input. Check the controller Analog Input to determine the proper connection before applying power. Both current and

voltage signals are referenced to the COM terminal. The current output operates in the active mode and does not require a loop power supply (the signal current is generated by the transmitter and must not be connected to a powered input or device damage will result).

The optional relay output connects to the RELAY terminals. The relay output is completely isolated and has a Normally Open (NO) signal. This signal can be used to directly control an alarm or ventilation fan. See specifications for contact ratings. See Figure 8.

The optional override signal is a two-wire dry contact normally open switch connected to the SWITCH terminals. See Figure 9.

The optional setpoint signal is a resistive signal that can vary from 0-10K ohms (for example) to simulate a slidepot action. It is available on the SETPNT terminal and is referenced to COM. Several resistive values are available and the operation may be configured as normal or reverse acting via the Setup Menu. See Figure 9

The optional two-wire temperature sensor output is available with various RTDs and thermistors to suit all control applications and is available on the TEMP terminals. See Figure 9.

OUTPUT SCALING

The CO₂ output signal is scaled such that 4-20 mA (or 0-5 / 0-10 Vdc) equals 0-2000 ppm by default. The signal span may be changed via the Setup Menu from 1000 to 10,000 ppm in 500 ppm increments.

START-UP MODE

Verify the device is properly wired and connections are tight. Ensure the mA / VOLT switch is set for the correct signal type. Apply power and the LCD will indicate the software version number, the output signal type and then the sensor will begin a one minute warm-up countdown. When the warm-up time expires the device will enter normal mode.

NORMAL MODE

The sensor will begin reading the CO₂ level (and temperature if it is installed), output the correct analog signal and display the values on the LCD. If the relay is installed, the measurements will be compared to the setpoint and appropriate action taken. The keypad is monitored and if the <MENU> key is pressed the device will enter the Setup Menu. If the setpoint option is installed, then pressing either the <UP> or <DOWN> keys will cause the device to enter the setpoint mode. The Setup Menu can be accessed to configure the device for required operation.

RELAY MODE

The optional relay can be used as an alarm signal to indicate that a setpoint has been exceeded. For the basic CO₂ product, the relay may be configured via the Setup Menu as a high or low alarm and the setpoint value, hysteresis and on-delay time may be set. The relay will activate and close the contacts if the CO₂ measurement goes above the setpoint (for a high alarm) or below the setpoint (for a low alarm). If required, this action can be delayed by a time period (relay delay time) to prevent false alarms. After the relay is activated, the measurement must fall below the setpoint - hysteresis value (for a high alarm) or go above the setpoint + hysteresis value (for a low alarm) to deactivate the relay and open the contacts. The high/low assignment, setpoint, delay time and hysteresis values may all be programmed via the Setup Menu as required.

If the optional temperature sensor is installed, the relay operation may be assigned to operate as a temperature high or low alarm instead of a CO₂ alarm. All the same relay parameters may be configured to set up the alarm as required.

SETPOINT MODE

The optional setpoint control is operated by two front panel switches for <UP> and <DOWN> and the resistive output signal simulates a slidepot action with + and - 10 steps from the midpoint. For example, if the device is ordered with a 0-10KΩ resistance value, then the resistive output midpoint is 5KΩ and each press of the <UP> key will increase the output resistance by 500Ω up to 10KΩ and each press of the <DOWN> key will decrease the output resistance down to 0Ω. There are several optional "slidepot" values available for the product such as 20-30KΩ, 475-10,475Ω, etc and each range may be set as direct or reverse acting via the Setup Menu.

When either the <UP> or <DOWN> keys are pressed, the LCD temporarily changes to display the temperature setpoint value in °C or °F as set by Temp Units in the Setup Menu. The display will show the previous temperature setpoint setting such as 22 °C or 77 °F. If no other action is taken for 5 seconds then the device will reset to normal operation. While the display is still flashing the setpoint can be modified by pressing the <UP> or <DOWN> keys to increase or decrease the setpoint value. The LCD will update to show the new setpoint and the output signal will update accordingly. When the desired setpoint is shown on the LCD, leave the unit for 5 seconds to reset to normal operation and save the new setting. As the setpoint is changed the SETPNT output signal will change in resistance. The display midpoint and step resolution can both be programmed using the Setup Menu.

SETUP MENU

The device has several parameters that can be configured locally via the Setup menu using the keypad and LCD. Any changes made are saved in non-volatile memory and are restored in case of a power loss. The menu can be accessed at any time after the start-up mode and if there is 5 minutes of inactivity the menu will close and normal operation will continue.

To enter the menu, press and release the <MENU> key. This will enter the Setup Menu step 1, pressing the <MENU> key a second time saves the setting and advances to step 2. Each press of the <MENU> key saves the current setting and advances the menu item. The <UP> and <DOWN> keys are used to make changes to program variables by scrolling through the available options. The first column below shows what will be displayed on the LCD, including the default value.

<MENU> Press and release the <MENU> key to enter the Setup Menu

1. SPAN

CO₂ Span
2000 ppm

The CO₂ Span value controls the analog output scaling. CO₂ span can be changed from 1000 to 10,000 ppm in 500 ppm increments using <UP> or <DOWN>. If CO₂ Span = 2000 ppm, then the output signal is scaled 0-2000 ppm = 4-20 mA. Factory default is 2000 ppm.

<MENU> Press to advance to next menu item

2. SELF CALIBRATION

Self-Cal
ON

The Self-Cal feature <MENU> when enabled requires the sensor to be exposed to fresh air for at least one hour every twenty-four hours. When first installed the sensor requires a minimum of seven days of operation with fresh air exposer daily to allow the algorithm to adjust for self-calibration. Default for device is having this feature enabled "ON". If disabling this feature a manual calibration should be performed to ensure accuracy of the device.

<MENU> Press to advance to next menu item

3. ALTITUDE

Altitude
0 m

The Altitude value allows CO₂ compensation for local atmospheric pressure and altitude and ensures the highest CO₂ accuracy. Altitude can be changed from 0 to 2550 meters in 50 meter steps using <UP> or <DOWN>. It will take a few moments to change the setting, then the menu will advance to the next step. Factory default is 0 m (sea level).

<MENU> Press to advance to next menu item

4. OUTPUT VOLTAGE SPAN

V Output
0-5 Vdc

The V Output value controls the analog output voltage span if the PCB switch is set to VOLT. V Output can be set to either 0-5 Vdc or 0-10 Vdc using <UP> or <DOWN>. This setting has no effect if the PCB switch is set to mA. Factory default is 0-5 Vdc.

<MENU> Press to advance to next menu item

5. OUTPUT SIGNAL DIRECTION

Output
Direct

The Output value controls the analog output signal direction. Use <UP> or <DOWN> to change the setting from Direct (4-20 mA, 0-5 Vdc or 0-10 Vdc) to Reverse (20-4 mA, 5-0 Vdc or 10-0 Vdc) if reverse action is required. Factory default is Direct.

<MENU> Press to advance to next menu item

6. OUTPUT TEST

Output
Test OFF

The Output Test value controls the analog output signal for testing purposes. Use <UP> or <DOWN> to toggle the output signal to OFF (normal operation), MIN (minimum output) or MAX (maximum output). The actual output signal will depend on the PCB switch position (mA or VOLT) and the V Output setting (for voltage operation). Press <MENU> to set it back to OFF and advance. Factory default is OFF.

<MENU> Press to advance to next menu item

Only for **Temperature or Setpoint** Models

7. TEMPERATURE UNITS

Temp
Units °C

The Temp Units setting is used to select °C or °F display of temperature. Use <UP> or <DOWN> to select. The selection will also control available setpoint ranges if the setpoint option is installed. Factory default is °C.

<MENU> Press to advance to next menu item

8. DISPLAY

Display
CO₂ ppm

Display is used to control what information is displayed on the LCD. The selections depend on the installed options. Use <UP> or <DOWN> to select either CO₂ ppm, Temp, CO₂+Temp, Rotate or None. Factory default is CO₂ ppm. For a basic CO₂ only device, the selection is limited to CO₂ ppm or None.

CO ₂ ppm	Only the actual ppm value of the CO ₂ reading will be displayed	CO ₂ 1235 ppm	
Temp	Only temperature is displayed (°C or °F depends on units setting)	Temp 24.3 °C	
CO ₂ & Temp	CO ₂ ppm and temperature both displayed at the same time	1235 ppm 24.3 °C	
Rotate	All available sensor readings rotate at 2 second intervals	CO ₂ 1235 ppm	Temp 24.3 °C
None	No measurement information is displayed in normal mode, the setpoint information will still be displayed in setpoint mode, the menu will still display in Setup Menu mode		

<MENU> Press to advance to next menu item

9. BACKLIGHT

BackLite
Auto

The BackLite setting is used to control how the LCD backlight functions. Use <UP> or <DOWN> to select either Auto, Off or On. Auto means the backlight only lights when a menu is accessed or when the setpoint is activated (ie: when a key is pressed), Off means the backlight is always off and On means it is always on. Factory default is Auto.

<MENU> Press to advance to next menu item

Only if **Temperature Sensor** option Installed

10. TEMPERATURE OFFSET

T Offset
0.0 °C

The T Offset value allows calibration of the temperature value displayed on the LCD. Units (°C/°F) follow the Temp Units setting. Use <UP> or <DOWN> to add or subtract an offset from the temperature value. The range is -5.0 to 5.0 °C or -9.0 to 9.0 °F in 0.1° increments. Factory default is 0.0 °C.

<MENU> Press to advance to next menu item

11. RELAY

Relay
CO₂

The Relay setting allows the relay alarm to be assigned to either CO₂ High, CO₂ Low, Temp Hi or Temp Low as applicable. Use <UP> or <DOWN> to select. Factory default is CO₂ High. If the temperature sensor is not installed then the options will not be available.

<MENU>

Press to advance to next menu item

12. RELAY SETPOINT

Relay SP
1000 ppm

or

Relay SP
26 °C

The relay setpoint depends on the relay assignment set previously. Use <UP> or <DOWN> to change the setting within the limits as shown in the table. Note that only the one previous selection will be available. Note that a high alarm activates when the measurement exceeds the setpoint and a low alarm activates when the measurement goes below the setpoint. Use <MENU> to save and advance.

RELAY ASSIGNMENT	DEFAULT SETPOINT	SETPOINT RANGE	RESOLUTION
Temp High	26.0°C / 79.0°F	5.0 to 40.0°C / 40.0 to 100.0°F	0.5°
Temp Low	15.0°C / 59.0°F	5.0 to 40.0°C / 40.0 to 100.0°F	0.5°
CO ₂ High	1000 ppm	500 to 9000 ppm	100 ppm
CO ₂ Low	1000 ppm	500 to 9000 ppm	100 ppm

<MENU>

Press to advance to next menu item

13. RELAY HYSTERESIS

Relay Hy
50 ppm

or

Relay Hy
0.5 °C

The Relay Hysteresis will depend on how the relay is assigned. Units will either be in ppm for CO₂ or °C/°F for temperature.

Use <UP> or <DOWN> to change the Relay Hysteresis within the limits as shown in the table.

Note that a high alarm resets when the measurement goes below (setpoint - hysteresis) and a low alarm resets when the measurement goes above (setpoint + hysteresis). Note the value is somewhat dependent on the setpoint (ie: if the CO₂ setpoint is 500 ppm then the hysteresis cannot be 500 ppm).

RELAY ASSIGNMENT	DEFAULT SETPOINT	SETPOINT RANGE	RESOLUTION
Temp High or Low	0.5°C/F	0.2 to 5.0°C/F	0.1°C/F
CO ₂ High or Low	50 ppm	25 to 500 ppm	25 ppm

<MENU>

Press to advance to next menu item

14. RELAY DELAY

Relay
Dly 0min

Use <UP> or <DOWN> to change the Relay Delay time within the limits. The delay time may be set from 0 to 9 minutes in 1 minute increments to prevent false alarms. The default is 0 minutes (no delay).

<MENU>

Press to advance to next menu item

15. RELAY TEST

Relay
Test OFF

Use <UP> or <DOWN> to toggle the relay ON or OFF to test the relay operation. Press <MENU> to reset to OFF and advance.

<MENU>

Press to advance to next menu item

16. SETPOINT MIDPOINT

Use <UP> or <DOWN> to select the Setpoint Midpoint. Units are either C or F depending on the Temp Units setting.

*Setpoint
Mid 21 °C*

Note that the setpoint has + or - 10 steps from the midpoint.

For °C, the midpoint range is 18 to 25°C (resolution = 1°C, default = 21°C)
For °F, the midpoint range is 64 to 77°F (resolution = 1°F, default = 70°F)

<MENU> Press to advance to next menu item

17. SETPOINT ACTION

*Setpoint
Act FWD*

Use <UP> or <DOWN> to set the Setpoint Action to either FWD (forward) or REV (reverse). FWD means that as the setpoint value increases the output resistance increases. REV means that as the setpoint value increases the output resistance decreases. Factory default is FWD.

<MENU> Press to advance to next menu item

18. SETPOINT RESOLUTION

*Setpoint
Res 1.0°*

Use <UP> or <DOWN> to set the Setpoint Resolution to either 0.5° or 1.0° as required. The default is 1.0° which means that the setpoint will increase or decrease by 1° for every button press. The display will be 21.0, 22.0, 23.0, etc for example. For 0.5 resolution the display will be 21.0, 21.5, 22.0 for example. Factory default is 1.0. This applies to both °C and °F operation.

<MENU> Press to advance to next menu item

19. CO₂ CALIBRATION

*Calibrat Ref
1000 ppm*

The calibration reference screen allows user to set the calibration gas level used for calibrating the sensor. Use <UP> and <DOWN> to adjust the ppm value of calibration gas. The minimum value is 400ppm, the maximum value is 2000ppm. Increment value is 50ppm for each step. Press <MENU> to save and advance. If no calibration gas is available exposing the sensor to fresh outside can be used and calibrate with 400PPM value. Another method is to determine the CO₂ ambient level using a calibrated unit as a reference and adjust calibration setting to desired value

<MENU> Press to exit the menu and return to normal mode

20. CO₂ CALIBRATION

*Calibrat
1000 ppm*

The calibration screen is used for performing calibration of the sensor. To perform calibration of the sensor place calibration hood over sensor housing and apply calibration gas. Wait for several minutes and then press and hold <UP> or down button for five seconds until display shows "Calibrat Done" or "Calibrat Fail". Refer to Calibration section in this document for more details.

<MENU> Press to exit the menu and return to normal mode

CALIBRATION

Calibration with gas requires a field calibration kit (CDD1-CALKIT-GS) with pressure regulator, tubing, sensor adapter and bottle of CO₂ gas. The certified calibration gas is applied directly to the CO₂ sensor to perform a gas calibration.

Ensure the regulator knob is turned off and then hand tighten the regulator to the CO₂ gas bottle. A length of tubing should be connected between the regulator output and the sensor adapter hood.

Remove the cover of the device to be calibrated to expose the gas sensor. Carefully install the sensor adapter hood over the CO₂ sensor on the PCB. The adapter should fit snugly and securely over the sensor and remain in place during the entire calibration cycle. This will ensure a stable ppm CO₂ environment during calibration. Turn the regulator knob on to allow gas to flow to the sensor. The CO₂ reading on the LCD will begin to approach ppm level of calibration gas. Wait 3 to 5 minutes until the CO₂ reading stabilizes.

Enter the Setup Menu and use the <MENU> key to advance to the "Calibrat" item. Press and hold either the <UP> or <DOWN> key for 5 seconds to start the gas calibration. The LCD will indicate "Calibrat / Done" if the process was successful. If "Calibrat / Fail" is displayed then the process may have to be repeated. Press the <MENU> key to return to normal operation, shut off the gas supply and remove the sensor adapter.

SPECIFICATIONS

Gas Type Detected	Carbon dioxide (CO ₂)
Sensor Type	Dual channel non-dispersive infrared (NDIR)
Sensor Accuracy.....	± (30 ppm + 3% of measured value)
Measurement Range.....	0-2000 ppm (default), adjustable 1000-10,000 ppm
Temperature Dependency.....	±2.5 ppm/°C
Response Time	20 seconds (T63)
Warm-Up Time.....	1 minute
Sensor Coverage Area.....	100 m ² (1000 ft ²) typical
Sensor Life Span.....	>15 years
Transmitter Accuracy	±0.25% of span (including linearity, hysteresis and repeatability)
Power Supply	24 Vdc ±20% or 24 Vac ±10% (non-isolated half-wave rectified)
Protection Circuitry.....	Reverse voltage and transient protected
Input Voltage Effect.....	Negligible over specified operating range
Output Signal Type	4-20 mA (3-wire), 0-5 or 0-10 Vdc (field selectable)
Current Consumption.....	Current: 75 mA @ 24 Vdc max, 150 mA @ 24 Vac max Voltage: 50 mA @ 24 Vdc max, 100 mA @ 24 Vac max
Output Drive @ 24 Vdc	Current: 550Ω max Voltage: 10,000Ω min
Ambient Operating Range.....	0 to 50°C (32 to 122°F), 0 to 95 %RH non-condensing
Storage Conditions	-40 to 70°C (-40 to 158°F)
LCD Display Units	ppm (CO ₂), °C/°F (optional temperature/setpoint)
Display Range	0-10000 ppm, 0 to 50°C / 32 to 122°F
Display Size	35mm W x 15mm H (1.4" x 0.6")
Digit Height	2-line x 8 character

OPTIONAL TEMPERATURE SENSOR

Type.....	Various Thermistors and RTDs
Accuracy	Thermistors: ±0.2°C (±0.36°F) @ 25°C (77°F) Platinum RTD's: ±0.3°C (±0.54°F) @ 0°C (32°F) Nickel RTD's: ±0.4°C (±0.72°F) @ 0°C (32°F)
Range.....	0 to 50°C (32 to 122°F)
Output.....	2-wire resistive
Relay (Optional 2-wire output).....	Form A (N.O.), 2 Amps @ 140 Vac / 30 Vdc
Override Switch (Optional 2-wire output).....	50 mA @ 12 Vdc max

OPTIONAL SETPOINT CONTROL

Type.....	Front panel up/down pushbuttons
Range.....	±10 resistive steps, range 16 to 26°C in 0.5°C increments or 60 to 80°F in 1°F increments
Midpoint.....	Default 21°C/70°F, programmable 18 to 25°C (64 to 77°F)
Resolution	Programmable 0.5 / 1°C/°F
Action	Programmable direct or reverse acting

Enclosure	White ABS, IP30 (NEMA 1) 84mm W x 119mm H x 29mm D (3.3" x 4.7" x 1.15")
Wiring	Screw terminal block (14 - 22 AWG)
Approvals	CE
Country of Origin.....	Canada

DIMENSIONS

