

Installation Guide

Mounting

1. Clean the lines upstream from the valve. Remove any debris (welding slag, pipe scale, or other contaminants) larger than 1/16 inch (1.6 mm).

NOTE: If the system experiences large amounts of debris, steps should be taken to keep the system clean, such as 20 mesh strainer installed upstream of the valve.

2. Align the valve assembly according to the system flow requirements. VEF-56 three-way valves can be used in either mixing or diverting applications (see the VEF-56 3-Way Details section).

NOTE: No flange gaskets are needed because of the design of the seat face.

3. The valve may be mounted on either vertical or horizontal pipe lines. On horizontal lines, mount the valve so the actuator is positioned upright and over the valve. (Leave sufficient room on all sides to service the actuator and valve.)

⚠ CAUTION

To prevent condensation from dripping onto the actuator housing on horizontal lines, mount the valve with the actuator in the upright position or, at most, at a 90° angle. See the Mounting (2-Way and 3-Way) illustration below.

4. Bolt the valve to the pipes.
5. Eliminate air from the system to keep the valves full of fluid during operation.

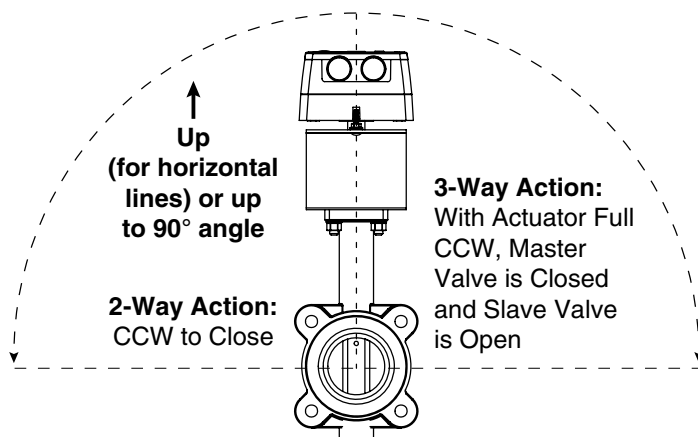

Mounting (2-Way and 3-Way)

VEF-56 3-Way Details

VEF-56 Arrangement	Master Valve (Actuator)	Slave Valve	Common Port
1	A	B	C
2	A	C	B
3	B	C	A
4	B	A	C
5	C	B	A
6	C	A </td <td>B</td>	B

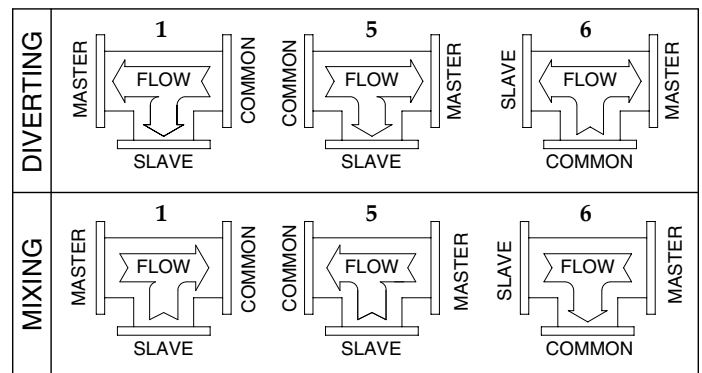
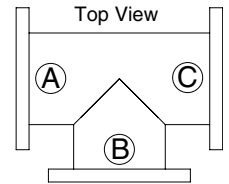

(Arrangements 2 and 4 not illustrated – see actuator illustration below for Arrangement 3)

Actuator full CCW:

- Master valve closed
- Slave valve open

Actuator full CW:

- Master valve open
- Slave valve closed

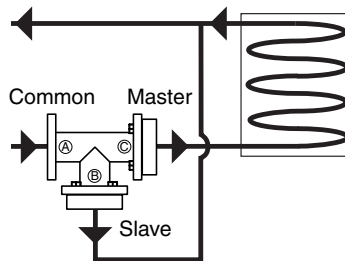
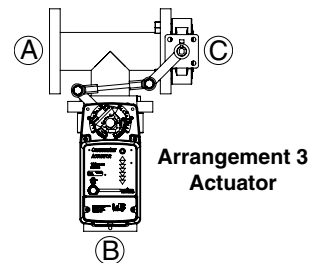

Arrangement 5 DIVERTING Flow Example

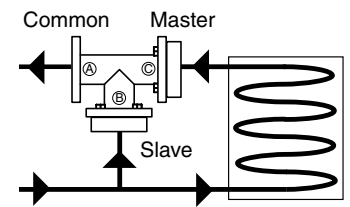

Arrangement 5 MIXING Flow Example

Maintenance

No routine maintenance is required. Careful installation ensures long-term reliability and performance.

Actuator Wiring

Wiring is dependent on the type of actuator, mounting, and the desired options that are available. Consult the actuator model label and then the relevant sections in the MEP-7500/7800 series actuators [installation guide](#) and [application guide](#) on the KMC Controls [web site](#) for detailed

instructions on the applicable wiring, feedback selector, and actuator/signal range reset (auto-mapping) of the valve's actuator. For dual, stacked actuators, follow the process below to access terminals in both actuators.

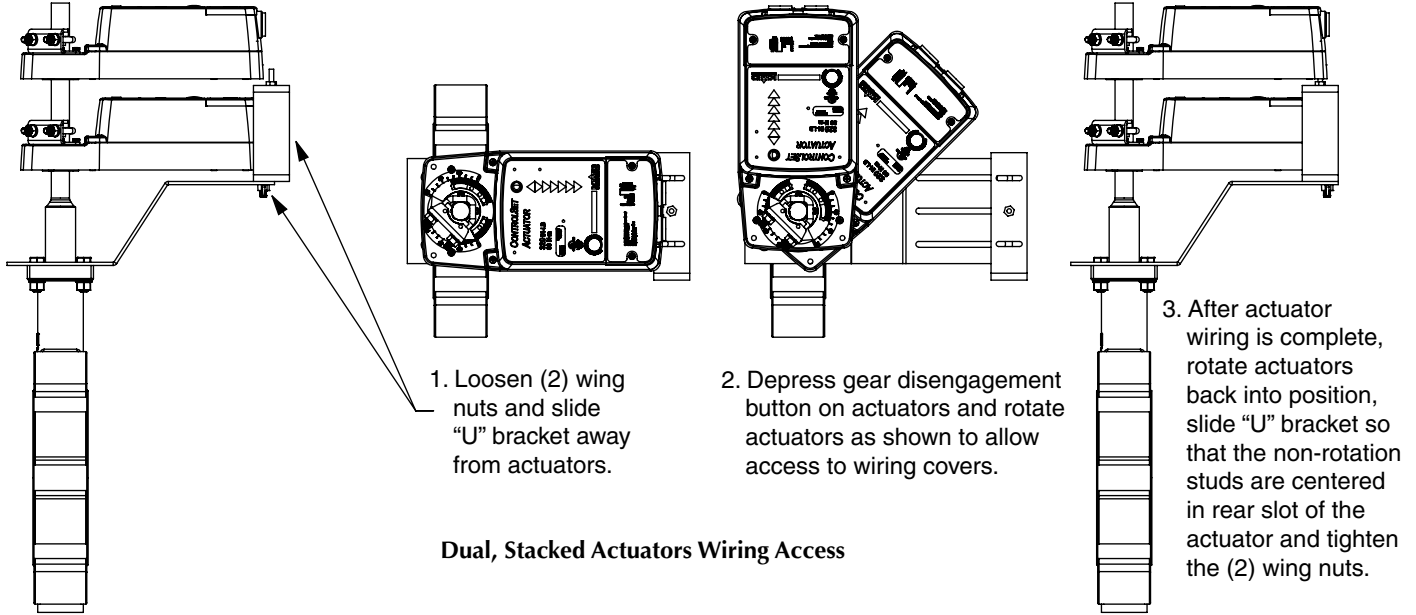

More Information

For valve models, specifications, and additional information, see the [VEB-56 Series Data Sheet](#) on the KMC web site (www.kmcccontrols.com).

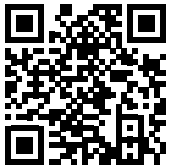
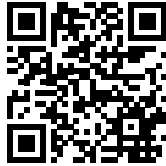

or the [VEB-53 Series Data Sheet](#).

For actuator wiring, feedback/direction selectors, actuator/signal range reset (auto-mapping), and other information, see the [MEP-7500/7800 Series Installation Guide](#).



For actuator master/slave wiring, accessories, troubleshooting, and other information, see the [MEP-7500/7800 Series Application Guide](#).

For actuator specifications and other information, see the [MEP-7500/7800 Series Data Sheet](#).



Operation

After the mechanical and electrical installations have been completed, cycle the actuator to verify the direction of rotation for normal operation and fail-safe if so equipped.

⚠ CAUTION

Using mineral oil lubricants or other incompatible substances in system fluids may damage EPDM rubber seats in valves. Before using any lubricant or additive in a water or ethylene glycol base, consult the substance manufacturer for compatibility with EPDM (Ethylene Propylene Diene Monomer).

⚠ CAUTION

Freeze protection required for fluid temperatures below 32° F (0° C).

KMC Controls, Inc.
19476 Industrial Drive
New Paris, IN 46553
574.831.5250

www.kmcccontrols.com; info@kmcccontrols.com